

# RD8000

Radiodetection's universal  
precision locator.



Operation Manual | Issue 1 | July 2008



**Radiodetection**  
AN SPX COMPANY



# Preface

## Before you begin

Thank you for your interest in Radiodetection's RD8000 cable and pipe locator.

The RD8000 delivers the very latest in cable and pipe location technology in a powerful yet ergonomic and light-weight design.

Please read this user manual before attempting to use the RD8000 system.

Radiodetection products, including this manual, are under continuous development. The information contained within is accurate at time of publication; however the RD8000, this manual and all its contents are subject to change.

Radiodetection Limited reserves the right to modify the product without notice and some product changes may have taken place after this user manual was published.

Contact your local Radiodetection dealer or visit [www.radiodetection.com](http://www.radiodetection.com) for the latest information about the RD8000 product family, including this manual.

## Important notices

### General

The performance of any cable and pipe locator may be affected when used in close proximity to ferrous materials such as manhole covers, steel-toe boots and nearby vehicles. Keep a distance of one or two meters from these objects when taking critical measurements such as depth and current readings.

This instrument, or family of instruments, will not be permanently damaged by reasonable electrostatic discharge and has been tested in accordance with IEC 801-2. However, in extreme cases temporary malfunction may occur. If this happens, switch off, wait and switch on again. If the instrument still malfunctions, disconnect the batteries for a few seconds.

### Safety

This equipment should be used by fully qualified and trained personnel only.

Radiodetection receivers detect almost all buried cables and most conductors, but there are some which do not radiate signals and which Radiodetection receivers cannot detect. Radiodetection receivers do not indicate whether a signal is from a single cable, several buried side by side

or one above another. Exercise caution and due diligence when conducting any survey.

Making a direct connection to live power lines is extremely dangerous to life. Do not attempt any direct connection unless you are fully trained and qualified to do so.

**⚠ WARNING! The transmitter is capable of outputting potentially lethal voltages. Take care when applying signals to any pipe or cable and be sure to notify other technicians who may be working on the line.**

Reduce audio level before using headphones to avoid damaging your hearing.

**⚠ WARNING! This equipment is NOT approved for use in areas where hazardous gases may be present.**

**⚠ WARNING! When using the transmitter, switch off the unit and disconnect cables before removing the battery pack.**

**⚠ WARNING! The RD8000 will detect almost all buried conductors but there are some objects that do not radiate any detectable signal. The RD8000, or any other electromagnetic locator, cannot detect these objects so proceed with caution. There are also some live cables which the RD8000 will not be able to detect in Power mode. The RD8000 does not indicate whether a signal is from a single cable or from several in close proximity.**

### Batteries

**⚠ WARNING! Alkaline batteries can get hot after prolonged use at full output power. Take care while replacing or handling the batteries.**

### Battery disposal

Ni-Cad batteries should be disposed of in accordance with your company's work practice, and/or the relevant laws or guidelines in your country or municipality.

### FCC and Industry Canada statements

This device complies with part 15 of the FCC Rules. Operation is subject to the following conditions: (1) This device may not cause harmful interference, and (2) this device must accept any interference received, including interference that may cause undesired operation.

Changes or modifications not expressly approved by the party responsible for compliance could void the user's authority to operate the equipment. To comply with the FCC RD explore compliance requirements, this device and its antenna must not be co-located or operated in conjunction with any other antenna or transmitter.

## Special *Bluetooth*<sup>®</sup> notice

RD8000 locators and transmitters contain a Class 1 *Bluetooth*<sup>®</sup> device that can emit radio frequency energy during the operation of certain product features. While the *Bluetooth*<sup>®</sup> device is busy, pairing or sending iLOC<sup>™</sup> commands from the locator to the transmitter, or sending SurveyCERT<sup>™</sup> data, always ensure a minimum separation of 200mm (8 inches) between the *Bluetooth*<sup>®</sup> antenna and your body. The location of the antenna is shown in Figure 2.2.

## Wireless technology compliance

Use of iLOC<sup>™</sup> wireless technology where applicable may be subject to national telecommunication regulations. Check with your local government authorities for further information.

## Training

Radiodetection provides training services for most Radiodetection products. Our qualified instructors will train equipment operators or other personnel at your preferred location or at Radiodetection headquarters.

For more information go to [www.radiodetection.com](http://www.radiodetection.com) or contact your local Radiodetection representative.

## Trademarks

RD8000, RD4000, SurveyCERT, eCAL, *Centros*, TruDepth, *SideStep*, *SideStepauto*, *StrikeAlert* and iLOC are trademarks of Radiodetection Ltd.

The Bluetooth word mark and logos are owned by the Bluetooth SIG, Inc. and any use of such marks by Radiodetection is under licence.

Windows, Windows Vista and XP are registered trademarks of Microsoft Corporation, all rights reserved.

## Copyright statement

This manual is Copyright © 2008 Radiodetection LTD. All rights reserved. Radiodetection LTD is a subsidiary of SPX Corporation.

This manual may not be copied, reproduced or sold in whole or in part without expressed written permission by Radiodetection Ltd. Please direct all copyright and publishing queries to your local Radiodetection representative.

# Table of contents

<b>Preface</b>	i		
Before you begin	i		
Important notices	i		
General	i		
Safety	i		
Batteries	i		
FCC and Industry Canada statements	i		
Special <i>Bluetooth</i> <sup>®</sup> notice	ii		
Wireless technology compliance	ii		
Training	ii		
Trademarks	ii		
Copyright statement	ii		
<b>Section 1. – Introduction</b>	1		
1.1 About this manual	1		
1.1.1 Additional documentation	1		
1.2 About the RD8000	1		
1.3 Manual outline	1		
1.4 Safety	1		
<b>Section 2. – System overview</b>	3		
2.1 RD8000 receiver	3		
2.1.1 Receiver features	3		
2.1.2 Receiver keypad	3		
2.1.3 Receiver screen icons	3		
2.2 Tx1, Tx3 and Tx10 transmitters	5		
2.2.1 Transmitter features	5		
2.2.2 Transmitter keypad	5		
2.2.3 Transmitter screen icons	5		
<b>Section 3. – Basic Operation</b>	6		
3.1 Starting the system	6		
3.1.1 Batteries	6		
3.2 System setup	6		
3.2.1 Power frequency (receiver only)	6		
3.2.2 Language	7		
3.2.3 Units (receiver only)	7		
3.2.4 Battery type	7		
3.3 Using the menu	7		
3.3.1 Navigating the receiver menu	7		
3.3.2 Receiver menu options	7		
3.3.3 iLOC <sup>™</sup> commands	8		
3.4 Shutting down	8		
3.5 Headphones	8		
3.6 Frequencies	8		
3.6.1 Passive frequencies	8		
3.6.2 Active frequencies	8		
3.6.3 Selecting frequencies	9		
3.7 TruDepth <sup>™</sup> measurement	9		
3.8 SideStep <sup>auto</sup> <sup>™</sup>	9		
3.8.1 Using SideStep <sup>auto</sup>	9		
3.9 Dynamic overload protection	9		
3.10 Passive avoidance	10		
3.11 StrikeAlert <sup>™</sup>	10		
3.11.1 Using StrikeAlert	10		
3.12 Antenna modes	10		
3.13 Audio	10		
3.14 Backlight	11		
3.15 Transmitter power output	11		
3.15.1 Adjusting power output	11		
3.15.2 Boost (Tx3 and Tx10 only)	11		
<b>Section 4. – Using SurveyCERT<sup>™</sup></b>	12		
4.1 Saving measurements	12		
4.2 Uploading measurements	12		
4.3 Erasing measurements	12		
<b>Section 5. – <i>Bluetooth</i><sup>®</sup> features</b>	13		
5.1 About wireless connections	13		
5.2 SurveyCERT <sup>™</sup>	13		
5.3 Pairing to a PC (SurveyCERT)	13		
5.3.1 Connection requirements	13		
5.3.2 Pairing	13		
5.4 Pairing to a PDA (SurveyCERT)	14		
5.4.1 Connection requirements	14		
5.4.2 Pairing	14		
5.5 Troubleshooting	15		
5.5.1 Resetting connections	15		
5.5.2 Switching <i>Bluetooth</i> <sup>®</sup> off	15		
5.5.3 <i>Bluetooth</i> <sup>®</sup> error codes	15		
<b>Section 6. – iLOC<sup>™</sup></b>	16		
6.1 About iLOC	16		
6.2 Pairing iLOC	16		
6.3 Changing frequencies	16		
6.4 SideStep <sup>™</sup>	17		
6.5 Adjusting power	17		
<b>Section 7. – Locating cables and pipes</b>	18		
7.1 Antenna modes	18		
7.1.1 Peak mode	18		
7.1.2 Single antenna mode	18		
7.1.3 Null mode	18		

7.1.4 Peak/Null mode	19	10.5.2 How to use a stethoscope	34
7.2 Compass	19	10.5.3 Types of stethoscope	34
7.3 Trace	19	10.6 Submersible antenna	34
7.4 Pinpoint	19	10.6.1 When to use a submersible antenna	34
7.5 Sweep and search	20	10.6.2 How to use a submersible antenna	34
7.5.1 Passive Sweep	20	<b>Section 11. – Fault-Finding</b>	36
7.5.2 Inductive search	20	11.1 About fault-finding	36
<b>Section 8. – Depth and current readings</b>	22	11.2 Preparation	36
8.1 Depth readings	22	11.2.1 Connecting the transmitter	36
8.1.1 TruDepth and Compass	22	11.2.2 Reference readings	36
8.2 Verifying depth measurements	23	11.3 How to find a fault	37
8.2.1 Rough depth calibration check	23	<b>Section 12. – Current direction (CD)</b>	38
8.3 Current readings	24	12.1 Understanding CD	38
8.3.1 Identification using current measurements	24	12.1.1 Using Current Direction (CD) to aid identification	38
8.3.2 About current measurements	24	12.2 CD reset	39
8.2.3 Applying a transmitter signal	25	12.2.1 About CD reset	39
8.2.4 Signal current measurements	25	12.2.2 Using a CD clamp or stethoscope	39
<b>Section 9. – General Locating tips</b>	26	12.2.3 Performing a CD reset	39
9.1 Eliminating services	26	<b>Section 13. – Appendices</b>	40
9.1.1 Induction	26	13.1 Care and maintenance	40
9.1.1 Unwanted signal coupling	26	13.1.1 General	40
9.2 Signal grounding	27	13.1.2 Batteries and power supply	40
9.2.1 Manhole covers	27	13.1.3 Cleaning	40
9.2.2 Using lighting columns	27	13.1.4 Disassembly	40
9.2.3 Finding a good ground point	27	13.1.5 Service and maintenance	40
9.3 Double-ended connections	28	13.2 Upgrading firmware	40
9.3.1 Making a double-ended connection	28	13.3 eCAL™	40
<b>Section 10. – Using Accessories</b>	29	13.4 Specifications for the receiver and transmitter	41
10.1 About accessories	29	13.5 Supported frequencies	41
10.2 Receiver clamps	29	13.6 Supported accessories	42
10.2.1 When to use clamps	29		
10.2.2 Connecting a clamp	29		
10.2.3 Available receiver clamps	30		
10.3 Transmitter clamps	30		
10.3.1 Connecting the clamp	30		
10.3.2 Available transmitter clamps	31		
10.4 Sondes	31		
10.4.1 When to use a sonde	31		
10.4.2 Choosing a suitable sonde	31		
10.4.3 Preparation	31		
10.4.4 Propelling a sonde	31		
10.4.5 Locating and tracing a sonde	32		
10.4.6 Checking sonde depth	32		
10.4.7 Types and range of sondes	33		
10.5 Stethoscopes	34		
10.5.1 When to use a stethoscope	34		

## Table of figures

Figure 2.1: RD8000 receiver	2
Figure 2.2: RD8000 showing <i>Bluetooth</i> <sup>®</sup> antenna	2
Figure 2.3: receiver keypad	2
Figure 2.4: receiver LCD	2
Figure 2.5 RD8000 transmitter	4
Figure 2.6: Rechargeable battery pack	4
Figure 2.7: transmitter keypad	4
Figure 2.8 transmitter LCD	4
Table 5.1: <i>Bluetooth</i> <sup>®</sup> error codes	15
Figure 7.1 Line tracing	19
Figures 7.2: Pinpointing a target line	19
Figures 7.3: Pinpointing with Peak/Null	19
Figure 8.1: Taking a depth reading	22
Figures 8.2: Depth readings	22
Figure 8.3: Current readings	24
Figures 8.4 – 8.6: Taking current readings	24
Figure 8.7: Current readings using transmitter signals	25
Figures 9.1 – 9.4: Interference from services	26
Figure 9.5: Making double-ended connections	28
Figure 10.1: Connecting clamps	29
Figure 10.2: Standard clamp	30
Figures 10.3 – 10.4: Connecting transmitter clamps	30
Figure 11.5 CD clamp	31
Figure 10.6: Sonde deployment	32
Figure 10.7: Locating a sonde	32
Figure 10.8: Calculating sonde depth	32
Figure 10.9: Standard sonde	33
Figure 10.10: Super small sondes	33
Figure 10.11: Sewer sonde	33
Figure 10.12: FlexiTrace	33
Figure 10.13: Using a submersible antenna	35
Figure 11.1: Cable sheath fault-finding	37
Figure 11.2: Locating cable sheath faults with the receiver and A-frame	37
Figure 12.1: Current direction	38
Figure 12.2: CD reset	39





# Section 1. – Introduction

## 1.1 About this manual

This manual provides cable and pipe survey professionals with comprehensive operating instructions for the RD8000 receiver and transmitter system. Before operating the RD8000 system it is very important that you read this manual, noting all safety warnings and procedures.

### 1.1.1 Additional documentation

This manual introduces the Centros Manager software suite but provides only limited installation and operating instructions. The Centros Manager and SurveyCERT manuals are available to download from [www.radiodetection.com](http://www.radiodetection.com).

## 1.2 About the RD8000

The RD8000 system provides cable and pipeline locators with a fast, effective means of locating and mapping buried utilities.

The RD8000 product family includes two powerful receivers and three transmitters offering one, three or ten watt power output. Each transmitter and receiver is compatible with all RD4000 accessories.

The RD8000 receiver is ergonomically designed to provide the operator with a balanced, light weight tool that encourages extended use in most environments.

## 1.3 Manual outline

The rest of this section provides an overview of safety procedures and notices. Please review them before moving on to Section 2 and the rest of this manual

Section 2 provides an overview of the RD8000 system with annotated diagrams of the receiver and transmitter

Section 3 introduces basic setup and operation using the RD8000's menu system.

Section 4 introduces SurveyCERT for survey measurement and analysis.

Section 5 provides instructions on how to pair your RD8000 to your PDA or PC using *Bluetooth*<sup>®</sup> wireless technology.

Section 6 introduces iLOC, Radiodetection's advanced

remote control technology that allows you to control the transmitter using the RD8000 receiver.

Section 7 introduces the theory and practice of cable and pipe location using the RD8000 receiver and transmitter.

Section 8 introduces depth and current readings.

Section 9 provides general locating tips.

Section 10 introduces the range of accessories that are compatible with the RD8000.

Section 11 introduces cable sheath fault-finding using the RD8000 and an accessory A-frame.

Section 12 introduces current direction (CD) mode.

Section 13 includes several appendices with reference material and other technical information.

## 1.4 Safety

Please read this manual in its entirety before attempting to operate the RD8000 receiver or transmitter. Note all safety notices in the preface and throughout this manual.

Follow your company and national safety procedures and or requirements when operating this equipment in any environment or workplace. If you are unsure what policies or procedures apply, contact your company or site's occupational health and safety officer or your local government for more information.

Do not use this equipment if you suspect that any component or accessory is damaged or faulty.

Use authorized accessories only. Incompatible accessories may damage the equipment or give inaccurate readings.

Do not use iLOC<sup>™</sup> or *Bluetooth*<sup>®</sup> in areas where wireless communication devices are considered hazardous. Check local authorities for more information.

Keep this equipment clean and arrange for regular services with an authorized Radiodetection service center. More information can be found in the Appendix or from your local Radiodetection representative.

Do not attempt to open or dismantle any part of this equipment unless directed specifically by this manual. Doing so may render the equipment faulty and may void the manufacturer's warranty.

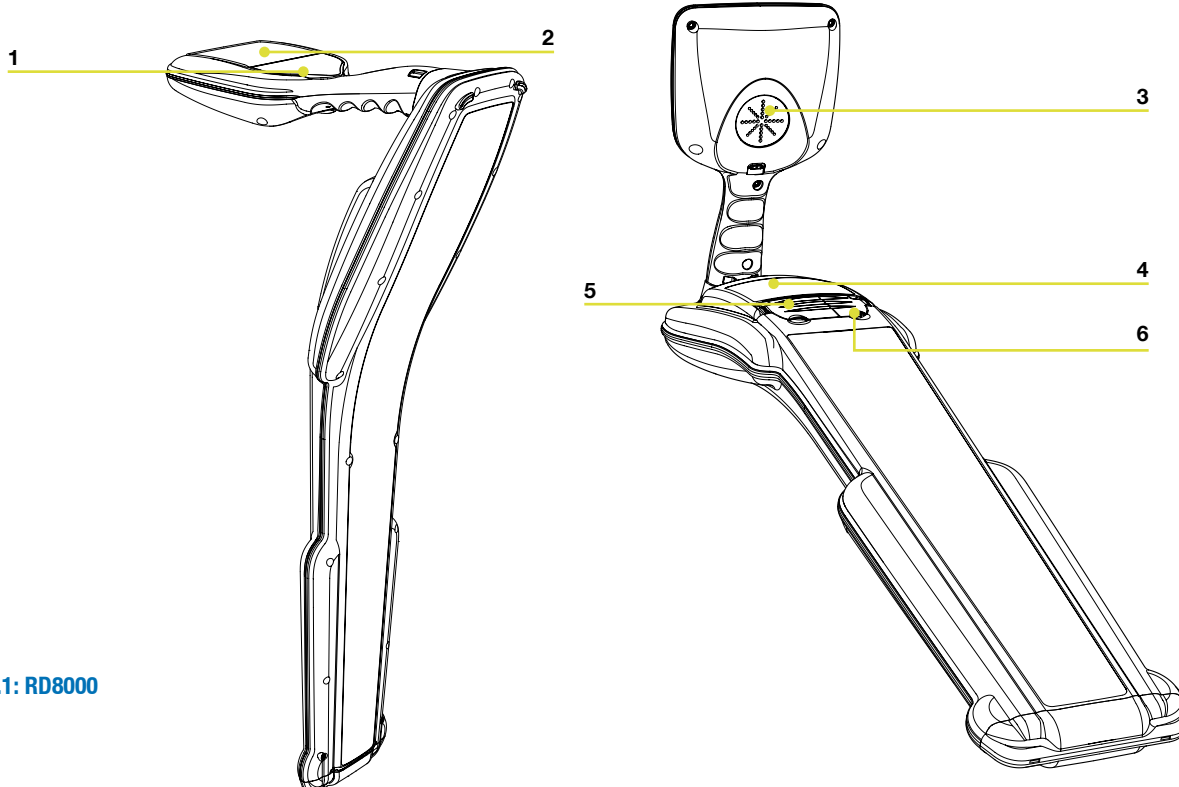

Figure 2.1: RD8000 receiver

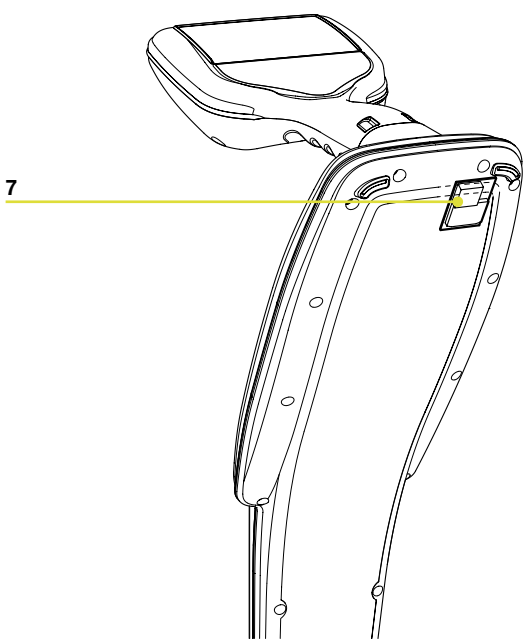

Figure 2.2: RD8000 showing Bluetooth® antenna

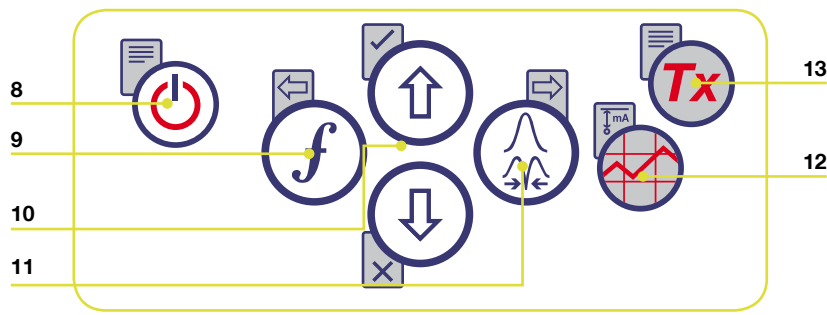

Figure 2.3: receiver keypad

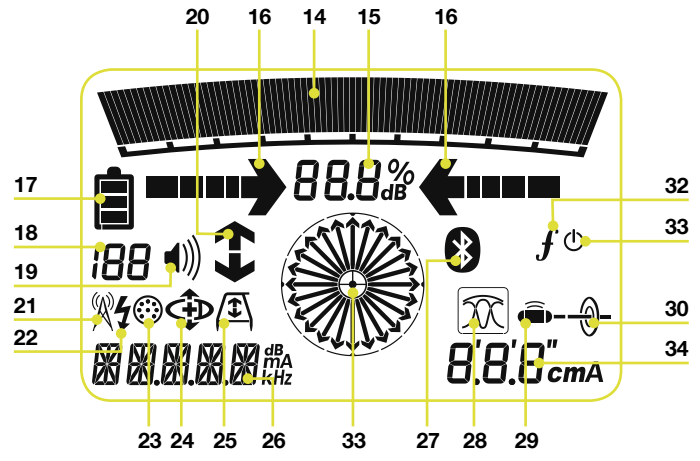

Figure 2.4: receiver LCD







# Section 2. – System overview

## 2.1 RD8000 receiver

### 2.1.1 Receiver features

1. Keypad.
2. LCD with auto backlight.
3. Speaker.
4. Battery compartment.
5. Accessory slot.
6. Headphone jack.
7. *Bluetooth*<sup>®</sup> module antenna.

### 2.1.2 Receiver keypad

8. Power key : Switches the unit on and off. Opens the receiver menu.
9. Frequency key : Selects frequency. Closes submenu.
10. Up and down arrows  : Adjusts the signal gain. Scrolls through the menu options.
11. Antenna key : Toggles peak, null, single antenna and combined peak/null modes. Opens a submenu. Prolonged key press toggles between depth or current display on the LCD.
12. Graph key : Saves SurveyCERT™ measurements.
13. Transmitter key : Sends iLOC™ commands on iLOC™ enabled receivers to iLOC™ enabled transmitters.

### 2.1.3 Receiver screen icons

14. Indicates the signal strength and peak marker.
15. Signal strength: Numerical indication of signal strength.
16. Peak / Proportional arrows: Indicates the location of the line relative to the receiver.
17. Battery icon: Indicates the battery level.
18. Sensitivity and Log number: Displays the log

number momentarily after a survey log is saved to memory.

19. Volume icon: Displays the volume level.
20. Current Direction arrows.
21. Radio Mode: Indicates when Radio Mode is active.
22. Power Mode: Indicates when Power Mode is active.
23. Accessory indicator: Indicates when an accessory is connected.
24. CD Mode icon: Indicates when Current Direction Mode is active.
25. A-Frame icon: Indicates when the A-Frame is connected.
26. Operating mode indicator.
27. *Bluetooth*<sup>®</sup> icon: Indicates status of *Bluetooth*<sup>®</sup> connection. Flashing icon means pairing is in progress. Solid icon indicates an established connection is active.
28. Antenna mode icon: Indicates antenna selection: Peak, Null, Single and combined Peak/Null.
29. Sonde icon: Indicates that the signal source is from a sonde.
30. Line icon: Indicates that the signal source is from a line.
31. Compass: Shows the direction of the located cable relative to the receiver.
32. Tx status: Displays transmitter connection status.
33. Tx standby: Indicates that the transmitter is in Standby Mode.
34. Current / depth indicator.

**Figure 2.5 RD8000 transmitter**

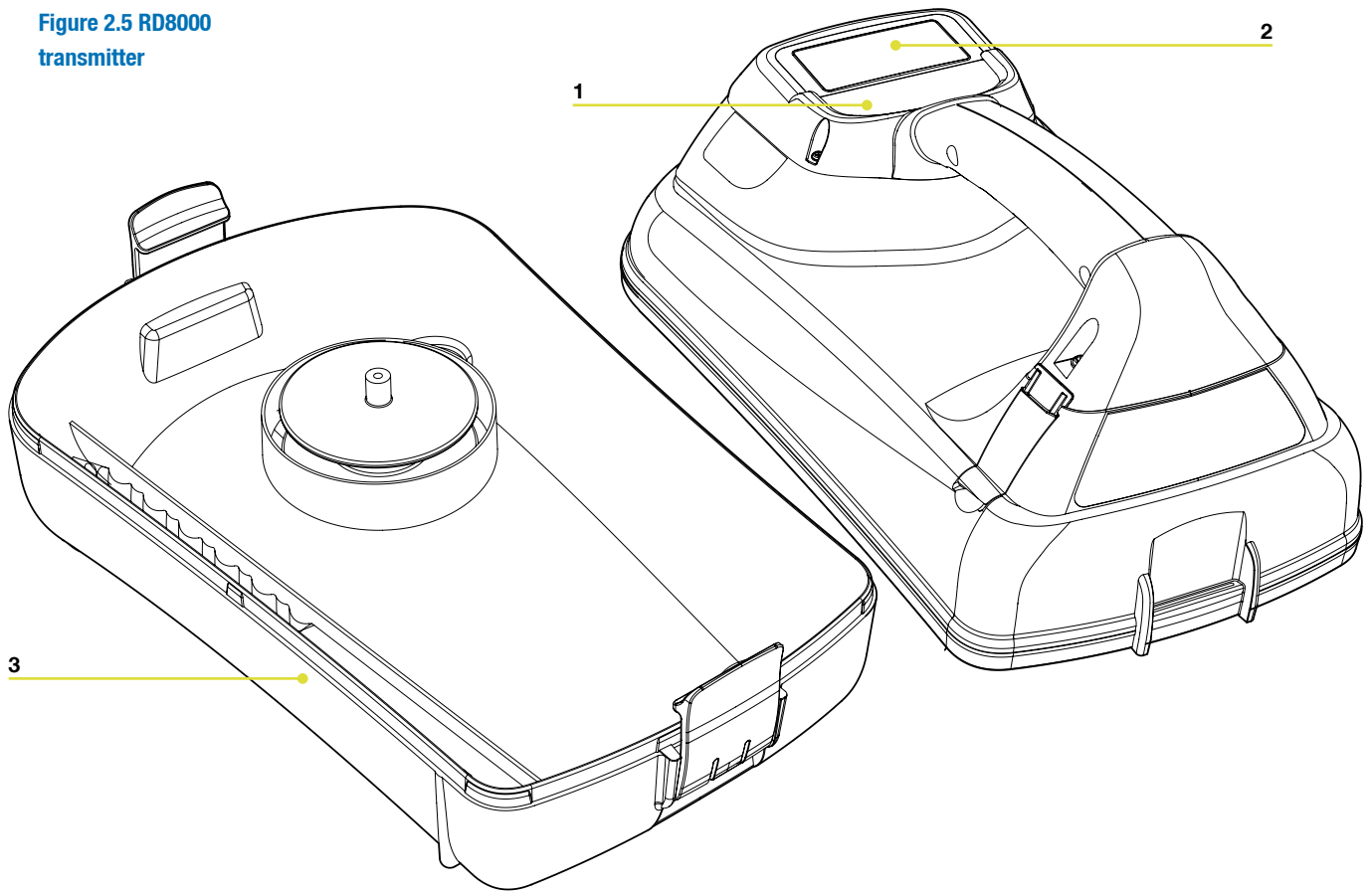

**Figure 2.6: Rechargeable battery pack**

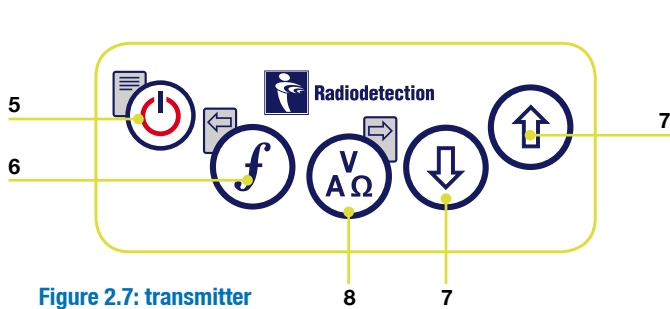
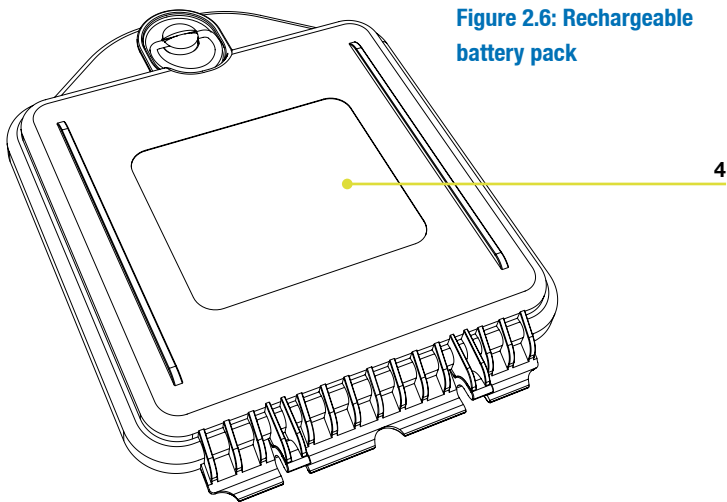

**Figure 2.7: transmitter keypad**

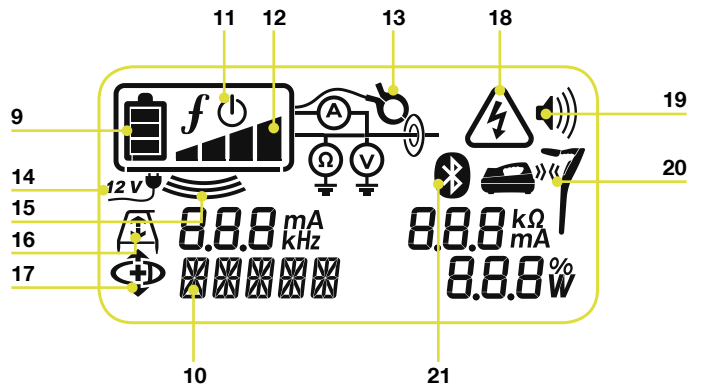





**Figure 2.8 transmitter LCD**

## 2.2 Tx1, Tx3 and Tx10 transmitters

### 2.2.1 Transmitter features

1. Keypad.
2. LCD.
3. Removable accessory tray.
4. Rechargeable battery pack.

### 2.2.2 Transmitter keypad

5. Power key : Switches the unit on and off. Opens the transmitter menu.
6. Frequency key : Selects frequency. Menu navigation key.
7. Up and down arrows  : Adjusts the output signal. Scrolls through the menu options.
8. Measure key : Toggles measurement display between volts, current and impedance. Note: displayed measurements are based on the currently selected mode or the attached accessory, if applicable. Opens a submenu.

### 2.2.3 Transmitter screen icons

9. Battery icon: Indicates the battery level.
10. Alphanumeric description of selected operation mode.
11. Standby icon: Appears when the transmitter is in Standby Mode.
12. Output level: Displays transmitter output power.
13. Clamp icon: Indicates when a clamp or other plug is connected.
14. DC icon: Appears when the transmitter is powered from a DC source.
15. Induction indicator: Appears when the transmitter is in Induction Mode.
16. A-Frame (Tx3 and Tx10 only): Indicates when the transmitter is in Fault-Find Mode.
17. CD Mode indicator (Tx10 only): Indicates that the transmitter is in Current Direction Mode.
18. Voltage warning indicator: Indicates that the transmitter is outputting potentially hazardous voltage levels.
19. Volume icon: Displays the volume level.

20. Pairing icon (Tx3B and Tx10B only): Appears when the transmitter and receiver are connected via iLOC™.
21. *Bluetooth*® icon (Tx3B and Tx10B only). Indicates status of *Bluetooth*® connection. A flashing icon means pairing is in progress.

# Section 3. – Basic Operation

## 3.1 Starting the system

The receiver and transmitter are battery powered. Install good quality D-cell NiMH or Alkaline batteries into the receiver and transmitter battery compartments. Alternatively, you can power the transmitter from a mains or vehicle power source using a Radiodetection supplied adapter.

To switch the receiver or the transmitter on, press and hold the keypad Power Key for two seconds. When you switch the system on it will perform an LCD segment check. It will then display the model number followed by the firmware version. This information is important if you need to contact Radiodetection technical support or update your receiver to the latest firmware.

**NOTE:** Once the system is switched on, pressing the Power Key momentarily will activate the receiver or transmitter menu.

### 3.1.1 Batteries

The LCD provides a battery level indicator (refer to the diagrams in Sections 2.1 and 2.2). When battery replacement is necessary, the LCD shows a flashing battery icon. The expected battery life under normal working conditions is approximately 30 hours on the receiver and 15 hours on the transmitter.

**NOTE:** Prolonged use of high power output on the transmitter will reduce battery life.

To replace the batteries on the receiver, unlatch the battery compartment cover, which is located above the accessory panel, and lower the tray. Remove the spent batteries and insert two D-Cell Alkaline or Ni-Cad batteries.

To replace the batteries on the transmitter, unlatch the accessory tray. The battery compartment is located underneath the transmitter body. Use the turnkey to unlatch the battery compartment. Remove the spent batteries and insert eight D-Cell Alkaline or Ni-Cad batteries.

**NOTE:** When installing batteries always observe the correct battery polarity as indicated on the battery tray.

### Rechargeable battery pack

An optional Lithium Ion rechargeable battery pack is available for the RD8000 Tx1, Tx3 and Tx10 transmitters.

The rechargeable battery pack offers an 8-hour lifespan, depending on use.

The pack is available in a kit that includes the rechargeable battery pack, AC adapter and a vehicle adapter.

The battery pack must be removed from the transmitter before it is connected to a power source for recharging. For more information, refer to the instructions that came with your charger.

**WARNING!** Do not heat the rechargeable battery pack above 60°C (140°F) as this will damage the battery's thermal fuses.

**NOTE:** The battery is designed to protect itself against over discharge, overcharge and short circuit between charge terminals.

Contact your local Radiodetection representative for information on purchasing battery packs and chargers.

## 3.2 System setup

It is important that you set up the system according to your personal preferences and operating requirements before you conduct your first survey. You can set the system up using the RD8000 menu as described below.





**NOTE:** These procedures refer to both the transmitter and receiver unless stated otherwise.

Before changing settings, ensure the receiver or transmitter is switched on by pressing the  key for two seconds.

### 3.2.1 Power frequency (receiver only)

Select the correct frequency (50 or 60Hz) for your country or region's national power supply.

**To change power frequency on the receiver:**

1. Press the  key momentarily to enter the menu.
2. Scroll to the POWER option using the arrow keys.
3. Press the  key to enter the POWER submenu.
4. Scroll up or down using the  or  arrows to select the correct frequency.
5. Press the  key to accept your selection and return to the main menu.







7

6. Press the  key to return to the main operation screen.

### 3.2.2 Language

The receiver and transmitter support a number of languages. You can specify your preferred language using the menu system.







#### To select your preferred menu language:

1. Press the  key momentarily to enter the menu.
2. Scroll to the LANG option using the arrow keys.
3. Press the  key ( on the transmitter) to enter the LANG submenu.
4. Scroll up or down using the  or  arrows to select your preferred language.
5. Press the  key to accept your selection and return to the main menu.
6. Press the  key to return to the main operation screen.

### 3.2.3 Units (receiver only)

The RD8000 allows you to work in Metric or Imperial (US customary) units.





#### To select your preferred units of measurement:



1. Press the  key momentarily to enter the menu.
2. Scroll to the UNIT option using the arrow keys.
3. Press the  key to enter the UNIT submenu.
4. Scroll up or down using the  or  arrows to select Metric or Imperial units.
5. Press the  key to accept your selection and return to the main menu.
6. Press the  key to return to the main operation screen.

### 3.2.4 Battery type

The RD8000 receiver and transmitter support both NiMH or Alkaline batteries. It is important that you set the system to match the currently installed battery type to ensure optimal performance and correct battery level indication.





#### To set your battery type:

1. Press the  key momentarily to enter the menu.
2. Scroll to the BATT option using the  or  arrows.
3. Press the  key ( on the transmitter) to enter the BATT submenu.







4. Scroll up or down to select the correct battery type.
5. Press the  key to accept your selection and return to the main menu.
6. Press the  key to return to the main operation screen.

The RD8000 is now ready to use.

## 3.3 Using the menu

The RD8000 receiver and transmitter menus allow you to select or change system options. Once entered, the menu is navigated using the arrow keys. Navigation is consistent on both the transmitter and the receiver. When in the menu, most on-screen icons will temporarily disappear and the menu options will appear in the bottom left-hand corner of the LCD. Note that when browsing the receiver menu, the  and  keys act as left and right arrows. When browsing the transmitter menu the  and  keys act as left and right arrows. The right arrow enters a submenu and the left arrow returns to the previous menu.

### 3.3.1 Navigating the receiver menu

1. First power up the receiver.
2. Press the  key to enter the menu.
3. Use the  or  arrows to scroll through the menu options.
4. Press the  key to enter the option's submenu.
5. Press the  key to return to the previous level.
6. Press the  key to return to the main operation screen.

7

### 3.3.2 Receiver menu options

Below is an annotated list of menu options that are available under the main menu of the RD8000 receiver.







- VOL: Adjust the speaker volume from 0 (mute) to 3 (loudest).
- LOG: Delete, send or review saved SurveyCERT measurements.
- BT: Enable, disable, reset or pair *Bluetooth*® connections.
- UNIT: Select metric or imperial units.
- LANG: Select your preferred system language.
- POWER: Select national power frequency: 50 or 60Hz.
- FREQ: Enable or disable individual frequencies.
- ALERT: Enable or disables *StrikeAlert*™.
- BATT: Sets battery type. NiMH or ALK.
- ANT: Enable or disable any antenna mode with the exception of Peak.

### 3.3.3 iLOC™ commands

The receiver's  key allows you to send commands to the transmitter or access the transmitter power menu.

For more information on iLOC, please refer to Section 6.

### 3.3.4 Navigating the transmitter menu

1. First power up the transmitter.
2. Press the  key to enter the menu.
3. Use the  or  arrows to scroll through the menu options.
4. Press the  key to enter the option's submenu.
5. Press the  key to return to the previous level or exit the menu.
6. Press the  key to return to the main operation screen.



### Transmitter menu options

- VOL: Adjust the speaker volume from 0 (mute) to 3 (loudest).
- BT: Enable, disable or pair *Bluetooth*® connections.
- MAX V: Set the output voltage.
- MODEL: Specify the model of your RD8000 receiver.
- MAX P: Allows the transmitter to output its maximum wattage.
- BATT: Set battery type. NiMH or ALK.
- OPT F: Enable or disable *SideStepauto*™.
- LANG: Select the transmitter system language.
- BOOST: Boost transmitter output for a specified period of time (in minutes).
- FREQ: Enable or disable individual frequencies.

## 3.4 Shutting down

To switch the receiver or the transmitter off, press and hold the  key for two seconds.

**NOTE:** The receiver will automatically power off if no keys are pressed after a five minute duration.

## 3.5 Headphones

Radiodetection supplies an optional headphone set for the RD8000 receiver. The headphones feature an adjustable headband to ensure a tight fit when used in the field. The accessory headphones also feature volume adjustment for both left and right speakers.

Connect the 3.5mm headphone jack into the receiver's headphone socket, which is located next to the accessory panel.

**NOTE:** Before wearing headphones, lower the receiver's volume levels to help prevent damage to your hearing.

**⚠ WARNING!** Wearing headphones may impede your awareness to dangers in the field such as moving traffic or other heavy machinery. Exercise caution!

## 3.6 Frequencies

The RD8000 supports a very large range of locatable, active and passive frequencies. For a complete list of supported frequencies, please refer to the table in Appendix 13.6.

### 3.6.1 Passive frequencies

Passive frequency detection takes advantage of signals that are already present on buried metallic conductors. The RD8000 supports four types of passive frequencies: Power, Radio, GPS and CATV signals. You can detect these frequencies without the aid of a transmitter if they are present on the utility you are surveying.

### 3.6.2 Active frequencies

Active frequencies are applied direct to a buried conductor using the transmitter. The transmitter can apply a signal using two methods: induction and direct connection.

#### Induction

The transmitter is placed on the ground over or near the survey area. You select the appropriate frequency. The transmitter will then induce the signal indiscriminately to any nearby metallic conductor. In induction mode, using higher frequencies is generally recommended as they are induced easier onto nearby conductors.

#### Direct connection

In direct connection, you connect the transmitter directly to the pipe or cable you wish to survey. The transmitter will then apply a discreet signal to the line, which you can locate using the receiver. This method provides the best signal on an individual line and enables the use of lower frequencies, which can be traced for longer distances.

Connecting the transmitter to a pipe or line requires the use of a direct connection lead or clamp and a ground stake to complete the circuit. For more information about signal clamps and other direct connection accessories, please refer to Section 10.



**⚠ WARNING!** Direct connection to live wires is **POTENTIALLY LETHAL**. Direct connections should be attempted by fully qualified personnel only!



### 3.6.3 Selecting frequencies

It is important to select the correct or appropriate frequency for your particular application. For more information see Section 6 or refer to the *ABC & XYZ of locating buried pipes and cables*, which is available as a free download from [www.radiodetection.com](http://www.radiodetection.com)



#### To select a frequency on the receiver:

1. Switch the unit on by pressing the  key, if you have not already done so.
2. Press the  key to cycle through available frequencies.
3. Alternatively, hold down the  key and press the up or down arrows to cycle up or down the range of frequencies.

7

If using an active frequency you must also set your transmitter to output the matching frequency. You can change your transmitter's output frequency manually using your transmitter's keypad or automatically using iLOC (iLOC enabled receivers and transmitters only).

#### To manually select a transmitter output frequency:

1. Switch the unit on by pressing the  key, if you have not already done so.
2. Press the  key to cycle through available frequencies.



To change frequencies using iLOC, please refer to Section 6.

**NOTE:** Some frequencies require that you connect an accessory, for example an A-Frame, before the frequency is available.

## 3.7 TruDepth™ measurement

The RD8000 uses TruDepth to automatically estimate depth when a good reading is established.

**NOTE:** TruDepth only indicates a locate depth when the receiver is correctly oriented directly above the detected pipe or cable.

To help you orient the receiver correctly, you can use the receiver's compass on the LCD.

Depth readings are displayed according to your preferred units of measurement as follows:

- Less than 1 meter: depth is displayed in centimeters
- Greater than 1 meter: depth is displayed in meters.
- Less than 3 feet: depth is displayed in inches.
- Greater than 3 feet: depth is displayed in feet.

For more information on measuring depth, please refer to Section 8.

## 3.8 SideStepauto™









SideStepauto allows the transmitter to calculate the optimum frequency based on ground impedance. The transmitter uses this information to optimize the active frequency. SideStepauto helps to improve locate accuracy by determining the best signal. SideStepauto can also help to prolong battery life.

**NOTE:** SideStepauto will only work in direct connection mode. Inductive frequencies are not supported.

### 3.8.1 Using SideStepauto









#### To enable SideStepauto



1. Switch on the transmitter.
2. Press the  key to enter the menu.
3. Scroll to the OPT F option using the  or  arrows.
4. Press the  key to enter the OPT F menu.
5. Scroll to the START option using the  or  arrows.
6. Press the  key to start SideStepauto and exit the OPT F menu.
7. Press the  key to exit the menu.

#### To disable SideStepauto



1. Switch on the transmitter.
2. Press the  key to enter the menu.
3. Scroll to the OPT F option using the  or  arrows.
4. Press the  key to enter the OPT F menu.
5. Scroll to the EXIT option using the  or  arrows.
6. Press the  key to disable SideStepauto and exit the OPT F menu.
7. Press the  key to exit the menu.

## 3.9 Dynamic overload protection

Dynamic overload protection (DOP) allows you to locate accurately in areas with high levels of electromagnetic interference, such as sub-stations and beneath high-voltage transmission lines. DOP works by disregarding signal spikes that would otherwise overwhelm the RD8000's digital signal processor. DOP is an integrated feature of the RD8000. No action is required by the user.

## 3.10 Passive avoidance

Passive avoidance mode allows you to survey an area quickly by detecting power and radio signals simultaneously. Passive avoidance is available on the RD8000PDL and PDLB only.

### To enable passive avoidance mode

1. Switch on the receiver.
2. Press the  key repeatedly until you find the PASSIV mode.









Passive avoidance mode is now selected. Perform your survey as required.

## 3.11 StrikeAlert™









StrikeAlert detects shallow power cables and warns the operator with an audible alarm. The alarm is characterized by a rapid warbling sound. StrikeAlert is enabled by default; you can enable and disable StrikeAlert using the procedure detailed below.

**NOTE: StrikeAlert will not sound when the receiver's volume is muted.**

### To disable StrikeAlert

1. Switch on the receiver.
2. Press the  key to enter the menu.
3. Scroll to the ALERT option using the  or  arrows.
4. Press the  key to enter the ALERT menu.
5. Scroll to the OFF option using the  or  arrows.
6. Press the  key to disable StrikeAlert and exit the ALERT menu.
7. Press the  key to exit the menu.

### To enable StrikeAlert

1. Switch on the receiver.
2. Press the  key to enter the menu.
3. Scroll to the ALERT option using the  or  arrows.
4. Press the  key to enter the ALERT menu.
5. Scroll to the ON option using the  or  arrows.
6. Press the  key to enable StrikeAlert and exit the ALERT menu.
7. Press the  key to exit the menu.

## 3.11.1 Using StrikeAlert

StrikeAlert works with passive power frequencies only. This includes the following modes:

- POWER
- PASSIV

When StrikeAlert is active, it will automatically sound when a shallow power cable is detected.

## 3.12 Antenna modes

The RD8000 receiver supports four antenna modes to suit your particular application or the local environment. These modes are:









- Peak mode.
- Single antenna mode.
- Null mode.
- Combined Peak/Null mode.
- For more information on selecting and using the various antenna modes to assist with cable and pipe location, please refer to Section 7.1.

## 3.13 Audio

The transmitter and receiver feature an internal speaker to provide critical warnings or assist with cable and pipe location. The transmitter by default will also sound a pulsing tone to indicate that it is transmitting correctly.

### To adjust receiver audio:

**⚠ WARNING! Muting audio on the receiver will disable StrikeAlert.**

1. Switch on the receiver.
2. Press the  key to enter the menu.
3. Scroll to the VOL option using the  or  arrows.
4. Press the  key to enter the VOL menu.
5. Use the  or  arrows to select the desired volume level where 0 is mute and 3 is loudest.
6. Press the  key to accept the change and exit.
7. Press the  key to exit the menu.

### To adjust transmitter audio levels:



1. Switch on the transmitter.
2. Press the key to enter the menu.
3. Scroll to the VOL option using the or arrows.
4. Press the key to enter the VOL menu.
5. Use the or arrows to select the desired volume level where 0 is mute and 3 is loudest.
6. Press the key to accept the change and exit.
7. Press the key to exit the menu.

## 3.14 Backlight

The transmitter and receiver feature a backlight to improve LCD visibility when required. The receiver's backlight is controlled by an ambient light sensor and does not require adjustment by the user.

The transmitter's LCD backlight is activated whenever you press a key. The backlight will automatically switch off after a few minutes.

## 3.15 Transmitter power output

The transmitter supports several power output modes to help you select the optimal settings for your requirements whilst helping to prolong battery life.

### 3.15.1 Adjusting power output

**NOTE:** On iLOC enabled models, you can adjust the transmitter's power output remotely using the receiver. For more information, please refer to Section 6.

#### To adjust the power output:

1. Switch on the transmitter.
2. Press the or keys to increase or decrease power output.

### 3.15.2 Boost (Tx3 and Tx10 only)

Boost allows the transmitter to output its maximum wattage for a specified period of time in minutes.

**⚠ WARNING! The transmitter is capable of outputting potentially lethal wattages. Exercise extreme caution when using Boost.**

### To configure boost:



1. Switch on the transmitter.
2. Press the key to enter the menu.
3. Scroll to the BOOST option using the or arrows.
4. Press the key to enter the BOOST menu.
5. Set the BOOST duration using the or arrows. You can choose 5, 10, 15 and 20 minute periods.
6. Press the key to accept your changes and exit the BOOST menu.
7. Press the key to exit the menu.

### To enable boost:



1. First configure the boost duration using the procedure above.
2. Press and hold the arrow until BOOST appears on the transmitter LCD.
3. The transmitter will automatically exit boost mode after the allotted duration.

### To disable boost

1. Press and hold the arrow to switch boost off.

# Section 4. – Using SurveyCERT™

The RD8000 is capable of recording survey measurements to internal flash memory. When a measurement is taken and saved, the RD8000 will store the following information:

- log number
- current
- gain
- depth
- signal
- phase
- frequency

**NOTE:** The survey measurement schema is detailed in the SurveyCERT Operation Manual, available for download from [www.radiodetection.com](http://www.radiodetection.com)

When the receiver is paired to a GPS compatible PDA, SurveyCERT will append positional and temporal information to the data to provide it with a spatial context. Refer to Section 4 for more information about *Bluetooth*® pairing.

The RD8000 can store up to 1000 measurements in memory.

## 4.1 Saving measurements

To save a measurement, press  key.

To achieve accurate results the receiver must be kept as still as possible during the saving process.

The receiver will always save measurements to internal memory. If *Bluetooth*® is switched on, the receiver will also attempt to send the saved measurement to a paired PDA or PC. If your PC or PDA is out of reach, or if its *Bluetooth*® features are disabled, the receiver will display an error code. To avoid these errors, either switch off the receiver's *Bluetooth*® module or ensure that your PC or PDA is within range and correctly paired.

For more information about *Bluetooth*®, please refer to Section 5.

**NOTE:** A flashing reading means that the reading is poor and should be taken again. Poor readings may be caused by nearby conductors or sources of electromagnetic interference.

## 4.2 Uploading measurements

RD8000 measurements can be transferred wirelessly to your computer or PDA for post-survey analysis using SurveyCERT. Transferring the log requires SurveyCERT and a *Bluetooth*® connection. SurveyCERT handles the transfer to your PC or PDA and provides a charting feature to help you analyze your results.

If your PDA features a GPS receiver, SurveyCERT will automatically add GPS co-ordinate and timestamp information to your measurements and update them in real time.

Once the data is saved on your PC you can format it for analysis in the spreadsheet or GIS application of your choice.









For more information on uploading and manipulating survey measurements, please refer to the SurveyCERT operation manual freely available from [www.radiodetection.com](http://www.radiodetection.com).

## 4.3 Erasing measurements

The RD8000 allows you to delete all measurements. Erasing the log will wipe the RD8000 memory and is usually recommended when you begin a new survey.

**⚠ WARNING! Erasing measurements cannot be undone! Proceed with caution!**

To erase all stored measurements:

1. Press the  key to switch on the receiver.
2. Press the  key to enter to menu.
3. Press the  or  arrows to select LOG option.
4. Press the  key to enter the LOG menu.
5. Press the  or  arrow to select the DEL option.
6. Press the  key to make the selection and return to the main menu.
7. Press the  key to exit the menu.

7

# Section 5. – Bluetooth® features

## 5.1 About wireless connections

The RD8000 features a *Bluetooth*® wireless module. All RD8000 locators feature as standard the ability to connect to a PC or PDA. Selected RD8000 models feature iLOC, which allows wireless control over the transmitter by the receiver.

**NOTE:** The RD8000 wireless features maybe subject to national and or local regulations. Please consult your local authorities for more information.

**⚠ WARNING! Do not attempt any wireless connection in areas where such technology is considered hazardous. This may include: petrochemical facilities, medical facilities or around navigation equipment.**

## 5.2 SurveyCERT™

SurveyCERT is a Radiodetection application for Pocket PC and Windows XP. SurveyCERT can read and chart logged survey data for real-time or post survey analysis.

When used with a GPS receiver, SurveyCERT automatically appends survey data with positional information.

SurveyCERT and the SurveyCERT operation manual is available as a free download from [www.radiodetection.com](http://www.radiodetection.com)

### To download SurveyCERT:

1. Visit [www.radiodetection.com](http://www.radiodetection.com).
2. Using the menu bar, go to Support -> SurveyCERT -> RD8000.
3. SurveyCERT is bundled with Centros Manager. Follow the instructions on the page to download and install Centros Manager.

**NOTE:** By downloading and using Centros Manager you agree to the terms and conditions, which are published on the website.

## 5.3 Pairing to a PC (SurveyCERT)

All RD8000 models can connect to a compatible PC via the receiver's integrated *Bluetooth*® module. Connecting to a PC allows you to analyze your survey data with Radiodetection's SurveyCERT software or process it for analysis using commercial GIS packages.

### 5.3.1 Connection requirements

- Any RD8000 receiver.
- A PC desktop or notebook computer running Windows XP with Service Pack 2.\*
- USB *Bluetooth*® dongle or integrated *Bluetooth*® module.+
- SurveyCERT for Windows XP

\* Windows XP64 and Windows 2000 are not supported at this time.

+ Integrated *Bluetooth*® modules may vary in performance, depending on the make or module of your notebook computer. Radiodetection recommends using a USB Bluetooth dongle.

**NOTE:** Your *Bluetooth*® hardware (USB or integrated) must support the *Bluetooth*® Serial Port Profile to successfully pair with the RD8000 receiver.





### 5.3.2 Pairing

*Bluetooth*® devices must be paired before use. The following procedure provides an example of how to pair the RD8000 receiver with your PC







**NOTE:** This procedure is a guide only! The procedure for pairing your device may differ with your brand of computer or USB *Bluetooth*® dongle. Consult your computer or USB dongle's user documentation for more information.

### To pair your device:

On the RD8000 receiver:

1. Press the  key to switch on the unit.
2. Press the  key to enter the menu.
3. Press the  or  arrows to select the BT option.
4. Press the  key to enter the BT menu.

7

5. Scroll to the PAIR menu using the  or  arrows and press the  key to enter the PAIR menu.
6. Scroll to the BT-PC option using the  or  arrows.
7. Press the Left arrow and the receiver will attempt to pair with your PDA.
8. Press the  key to exit the menu.

On your PC:

1. Connect a USB *Bluetooth*<sup>®</sup> dongle to a free USB port on your PC.
  - a. Alternatively, if your PC – typically a notebook computer – features an integrated *Bluetooth*<sup>®</sup> module switch it on following the documentation that came with your PC.
2. Select Start -> Control Panel and double-click on Bluetooth Devices.
3. Click on Add to run the 'Add Bluetooth Device Wizard.'
4. Tick 'My device is set up and ready to be found' and click Next to search for the RD8000 receiver.
5. A device named RD8K\_xxx should appear. If it doesn't, make sure the RD8000 is in pair mode and click Search again.
6. Select the RD8K\_xxx and click Next.
7. Tick 'Use the passkey found in the documentation', enter 1234 as the passkey and click Next to pair with the RD8000 receiver.
8. Completing the 'Add Bluetooth Device Wizard' will be displayed for a successful pairing.
9. Note the incoming COM port assigned to the device as this is required to configure SurveyCERT and click Finish.

## 5.4 Pairing to a PDA (SurveyCERT)

All RD8000 models can connect to a compatible PDA via the receiver's integrated *Bluetooth*<sup>®</sup> module. Connecting to a PDA allows you to analyze your survey data in real time in the field with Radiodetection's SurveyCERT software for Pocket PC.









### 5.4.1 Connection requirements

- Any RD8000 receiver.
- A *Bluetooth*<sup>®</sup> enabled PDA running Windows Mobile 4.5 or later.
- SurveyCERT for Pocket PC.
- GPS receiver (optional).

### 5.4.2 Pairing

Pair the RD8000 to your PDA using your PDA's *Bluetooth*<sup>®</sup> software. Note that the procedure for pairing your PDA may differ depending on the PDA model and the version of operating system it is running. This following procedure should apply to most PDAs running Windows Mobile 5.

On the receiver:

1. Power up the receiver.
2. Press the  key to enter the menu.
3. Scroll to the BT menu using the  or  arrows.
4. Press the  key to enter the BT menu.
5. Scroll to the PAIR menu using the  or  arrows and press the  key to enter the PAIR menu.
6. Scroll to the BT-PC option using the  or  arrows.
7. Press the Left arrow and the receiver will attempt to pair with your PDA.

On your PDA:

1. From the PDA's Start menu, select Settings then select the Connections Tab followed by the *Bluetooth*<sup>®</sup> icon.
2. Ensure the *Bluetooth*<sup>®</sup> radio is switched on and make the PDA visible to other devices.
3. Select the Devices tab and scan for new partnerships.
4. Create a partnership with the RD8K\_xxx device.
5. If asked for a passkey, enter 1234.
6. Select the COM Ports tab and make a New Outgoing Port with the RD8000. Note the port number of the selected COM port.

7

## 5.5 Troubleshooting

Successful wireless communication depends on a number of factors including: battery life, electromagnetic interference, device memory and physical obstructions.

Ensure that the RD8000 transmitter, receiver and any other wireless device is sufficiently charged for wireless communication. Note that many PDAs will suspend wireless connections when their battery capacity drops below a threshold percentage. Consult your device's documentation for more information.

Excessive electromagnetic interference can effectively limit the range of wireless communication and / or corrupt data.







Your PDA device may have insufficient memory to maintain a wireless link, particularly if the connection is sustained over an hour or longer. Make sure you quit applications on your PDA using the method described in your device's documentation.

Although iLOC can successfully function at distances up to 800m (in direct line of sight), your PDA (or notebook) and the RD8000 must be within 10m (30 feet) to maintain a wireless connection.

### 5.5.1 Resetting connections

If you experience problems with the RD8000's wireless technology features, Radiodetection recommends resetting the connection and then pairing your device again.





#### To reset the wireless connections:

1. Press the  key to enter the menu.
2. Scroll to the BT menu using the  or  arrows.
3. Press the  key to enter the BT menu.
4. Scroll to the RESET menu using the  or  arrows.
5. Press the  key and the receiver will purge all current connections.
6. Re-pair your devices as described in Sections 5.3 and 5.4.

### 5.5.2 Switching *Bluetooth*® off

You can switch *Bluetooth*® off to prolong battery life or comply with regulations in areas where wireless communications are considered hazardous.

#### To switch *Bluetooth*® off:

1. Press the  key to enter the menu.
2. Scroll to the BT menu using the  or  arrows.
3. Press the  key to enter the BT menu.
4. Scroll to the OFF option using the up or down arrows.
5. Press the  key to switch *Bluetooth*® and return to the previous menu.

### 5.5.3 *Bluetooth*® error codes

If an error occurs when attempting to perform any *Bluetooth* command using the receiver to the transmitter or the receiver to a PC or PDA, the LCD will display a code to help you resolve the problem on the receiver.

The codes are as follows:

BT Code	Description
BT001	<i>Bluetooth</i> ® NOT configured for this unit
BT002	Ezurio initialization command strings error
BT003	Not paired with transmitter
BT004	Not paired with PC/PDA
BT005	Paired but connection attempt failed
BT006	NAK response received from transmitter
BT007	Bad response (not ACK or NAK) received from transmitter
BT008	No response received from transmitter

Table 5.1: *Bluetooth*® error codes

# Section 6. – iLOC™











## 6.1 About iLOC

iLOC is a standard feature of the RD8000 PXLB and PDLB. To use iLOC, the transmitter and receiver must be paired using the procedure in Section 6.2.

iLOC lets you control the transmitter remotely using your RD8000 receiver. With iLOC you can adjust the output frequency, power settings and use SideStep. iLOC commands are sent over a *Bluetooth*® module that can operate at distances of up to 800 meters in direct line of sight.







## 6.2 Pairing iLOC

### On the receiver:

1. Power up the receiver by pressing the  key.
2. Once the receiver is switched on, press the  key again to enter the menu.
3. *Bluetooth*® options are located in the BT menu, you can find it by using the  or  arrows to scroll through the options.
4. Press the  key to enter the BT menu.
5. Scroll to the PAIR menu using the  or  arrows and press the  key to enter the PAIR menu.
6. Scroll to the BT-TX option using the  or  arrows.
7. The receiver is now ready to pair, follow the instructions for the transmitter to continue.



7

### On the transmitter:

1. Power up the transmitter by pressing the  key.
2. Once the transmitter is switched on, press the  key to enter the menu.
3. Scroll to the BT menu using the  or  arrows and press the  key to enter the BT menu.
4. Scroll to the PAIR option using the  or  arrows.
5. The transmitter is now ready to pair.



### Pairing:

1. Once both devices are ready to pair press the  key on the transmitter and the  key on the receiver. You must press these keys within a 30 second window, otherwise the connection may time out.
2. The transmitter and the receiver will now attempt to pair.

When pairing is in progress, the transmitter and receiver will display a flashing *Bluetooth*® icon. Pairing can take up to a minute. If the pairing process is successful, the transmitter will display the icon and the receiver will display a persistent *Bluetooth*® icon for the duration of the connection.

If pairing fails, ensure that any nearby *Bluetooth*® devices are switched off or invisible then repeat the process.



Once the receiver and transmitter have successfully paired you can use iLOC™ to change the transmitter's output frequency and power levels remotely from the receiver.

## 6.3 Changing frequencies

Once the transmitter and the receiver are paired, you can change the transmitter's output frequency remotely using the receiver.

**NOTE:** in ideal conditions iLOC works at distances up to 800m in direct line of sight. Operating in built up areas and in areas with high electromagnetic interference may reduce iLOC's performance.

### To change frequencies:

1. Switch on the receiver and transmitter by pressing the  keys on their respective keypads.
2. Pair the receiver and the transmitter if you have not already done so.
3. On the receiver, select the frequency you want by pressing the  key until the frequency is displayed on screen.
4. iLOC commands are sent using the  key, press it to send the new frequency to the transmitter.







5. The receiver's LCD will display SEND momentarily and then OK if the transfer is successful.
6. If the transfer is unsuccessful, the LCD will display an error code. Refer to Section 5.5.3 for a list of codes and their meaning.

If the process fails, you may be out of range or there may be an error in the connection. Move closer to the transmitter and retry the procedure. If the connection continues to fail, return to the transmitter and reset the connection using the procedure described in Section 5.5.1.

## 6.4 SideStep™

SideStep allows you to change the output frequency on the transmitter. SideStep changes the selected frequency by several Hertz and automatically sets the receiver's locate frequency to match the transmitter's output frequency.





### To step the frequency:



1. Switch on the receiver and transmitter by pressing the  keys on their respective keypads.
2. Pair the receiver and the transmitter if you have not already done so.
3. On the receiver, select the frequency you want by pressing the  key until the frequency is displayed on screen.
4. To step the frequency, press and hold the  key until STEP appears on the LCD.
5. Press the  key to send the SideStep command to the transmitter.
6. If the command is sent successfully, an asterisk (\*) will appear next to the frequency on the receiver's LCD.

## 6.5 Adjusting power

iLOC lets you adjust the transmitter's power output remotely; you can also put the transmitter into standby mode and then wake it remotely.

### To adjust the power output:

1. Pair the receiver and the transmitter if you have not already done so.
2. Transmitter power options are located in the TXOUT menu on the receiver. Press and hold the  key to display the TXOUT menu.
3. Press the  key to enter the TXOUT menu.
4. Scroll through the power output options using the  or  keys; available options are:

- a. STDBY: Transmitter standby mode, the connection is still active but the output is disabled.
  - b. LOW: Low power output.
  - c. MED: Medium power output.
  - d. HIGH: High power output.
  - e. BOOST: Temporarily boosts transmitter power output to its maximum level.
5. Once you have selected the mode you want, press the  key to confirm.
  6. Next press and hold the  key to select the new setting and exit the menu.
  7. Press the  key once to send the settings to the transmitter.

If the process fails, you may be out of range or there may be an error in the connection. Move closer to the transmitter and retry the procedure. If the connection continues to fail, return to the transmitter and reset the connection using the procedure described in Section 5.5.1.

# Section 7. – Locating cables and pipes

This section introduces the principals and techniques of locating buried cable and pipe utilities with the RD8000 system. For more information on the theory of cable and pipe location, please refer to *ABC & XYZ of locating buried pipes and cables*, which is available from [www.radiodetection.com](http://www.radiodetection.com)

## 7.1 Antenna modes

The RD8000 system supports four antenna modes to suit your particular application or the local environment. These modes are:

- Peak mode.
- Single antenna mode.
- Null mode.
- Peak/Null mode.



### 7.1.1 Peak mode

Peak mode provides the most sensitive and accurate mode for location and depth measurement. It provides a sharp peak response with a corresponding small decrease in sensitivity. Peak mode cannot be disabled using the menu.

In peak mode the following indicators are displayed by the LCD:

- Depth.
- Current.
- Signal strength.
- Compass.

#### To select a peak mode:

1. Press and release the  key to switch the receiver on.
2. Press the  key until the peak mode icon  is displayed on the LCD.

### 7.1.2 Single antenna mode





In Single Antenna mode, the RD8000 will detect with higher sensitivity over a wider area than peak mode. This is particularly useful for locating deep utilities quickly and indiscriminately. Once you have located a target in single

antenna mode, you should then use Null or Peak modes to gain a more accurate location as single antenna mode is unable to pinpoint the location of the target line.

In single antenna mode the following indicators are displayed by the LCD:

- Depth.
- Current.
- Signal strength.
- Compass.

#### To select single antenna mode:

1. Press and release the  key to switch the receiver on.
2. Press the  key to select your preferred frequency.
3. Press the  key until the single antenna mode icon  is displayed on the LCD.



### 7.1.3 Null mode

Null mode is used to verify a locate signal in environments with limited or no electromagnetic distortion.

In null mode the following indicators are displayed by the LCD:

- Signal strength.
- Compass.
- Right and left arrows.

#### To select null mode:

1. Press and release the  key to switch the receiver on.
2. Press the  key until the null mode icon  is displayed on the LCD.

Null mode gives a null response when it is directly over the line. The sharp, null response is easier to use than the peak response but is vulnerable to interference and should not be used for locating, except in areas where there is no interference present (See 7.1.4 Combined Peak/Null mode). In null mode, the receiver will indicate line position but not its orientation.

## 7.1.4 Peak/Null mode



Peak/Null mode give you the advantages associated with these modes simultaneously.

Use the proportional arrows to place the receiver above the NULL point. If the peak response is not at a maximum then this is evidence of a distorted field. If the peak response is at its maximum level where the NULL point is located then there is no or very limited distortion present. At this point, peak mode may be selected to obtain depth and current information.

In Peak/Null mode the following indicators are displayed by the LCD:

- Proportional right and left arrows.
- Signal strength.
- Compass.
- Current
- Depth

### To select Peak/Null mode:

1. Press and release the  key to switch the receiver on.
2. Press the  key until the Peak/Null mode icon  is displayed on the LCD.

## 7.2 Compass

The LCD compass provides a visual indication of the direction of the target cable, pipe or sonde. The compass is available when locating active frequencies as well as CATV and CPS passive frequencies. The compass however is unavailable when the receiver is set to detect Power and Radio signals.

## 7.3 Trace

Line tracing can be accelerated by switching the receiver to null response.

Move the receiver left and right while walking along the path of the line to observe the null directly over the line and a peak response to each side of the line. As you move the receiver over the line, the left and right arrows (and an accompanying tone) will indicate if the target line is to the left or right of the receiver.

Periodically switch to peak mode, locate the target line, and verify its exact position.

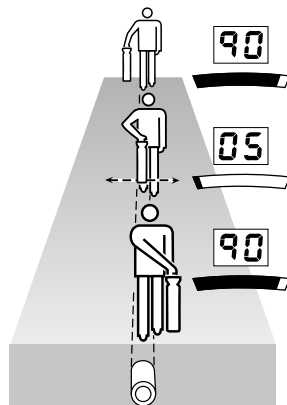

Figure 7.1 Line tracing

## 7.4 Pinpoint

Pinpointing a target line in peak mode, defines the exact position of a target line after it has been traced and its position is approximately known. Start with medium output power from the transmitter, medium frequency on the transmitter and receiver, and peak mode on the receiver.

Set the receiver sensitivity to approximately 50%.

**NOTE:** it may be necessary to adjust the sensitivity level throughout the pinpointing to keep the bar graph on scale.

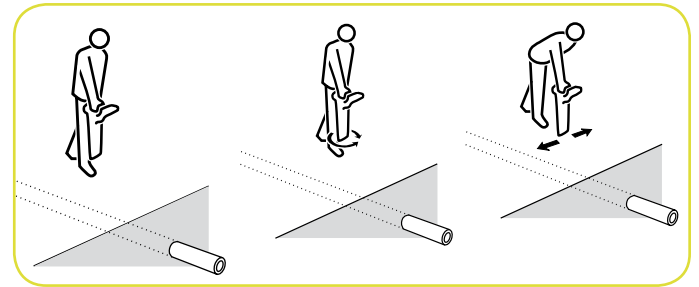

Figures 7.2: Pinpointing a target line

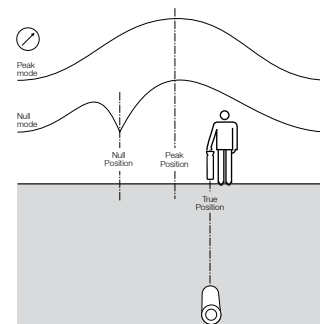

Figures 7.3: Pinpointing with Peak/Null

1. With the antenna perpendicular to the line, make traverses across the line. Define the point of maximum response.
2. Without moving the receiver, turn it round as if it is on a pivot. Stop at the point of maximum response.
3. Hold the receiver vertical with the antenna just above the ground and move the receiver from side to side across the line. Stop at the point of maximum response.
4. With the end of the antenna close to the ground, repeat steps 2 and 3.
5. Mark the position and direction of the line.

Repeat the steps of the procedure to increase pinpoint accuracy.

Switch to null response mode and move the receiver to find the null position. If the position of the peak and the null pinpoints correspond, it can be assumed that the pinpoint is precise. The pinpoint is not precise if the marks do not correspond, but both marks will show an error to the same side. True line position will be close to peak position.

The line lies half the distance to the other side of the peak position as the distance between the peak and the null positions.



## 7.5 Sweep and search

There are a number of techniques available for locating unknown lines in an area. Using these techniques is particularly important before conducting any excavation work to ensure that buried lines are not damaged.

### 7.5.1 Passive Sweep

A passive sweep will locate any Power, Radio, CATV or CPS signals that may radiating from buried conductors.

#### To perform a passive sweep:

1. Press and release the  key to switch the receiver on.
2. Press the  key to select the passive frequency you wish to locate. You can select from the following passive frequencies:
  - a. Power.
  - b. Radio.
  - c. CATV.
  - d. CPS.
  - e. PASSIV: simultaneously detects Power and Radio signals where present.
3. Adjust the sensitivity to maximum; reduce the sensitivity to keep the bar graph on scale when there is a response.
4. Traverse the area in a grid search (Figure 7.6), at a steady walk, and hold the receiver comfortably with the antenna in line with the direction of movement and at right angles to any lines that may be crossed.

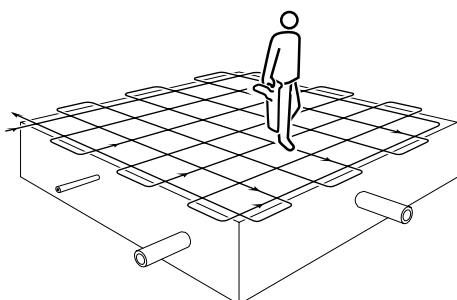

Figure 7.4:  
Passive sweep

Stop when the receiver response rises to indicate the presence of a line. Pinpoint the line and mark its position. Trace the line out of the area being searched. Resume grid search in the area.

In some areas there may be a confusing amount of 50/60Hz power signals. Lift the receiver 50mm from the ground and continue the sweep.

Switch the receiver to Radio Mode if the receiver supports this feature. Increase sensitivity to maximum and repeat the above grid search procedure over the area. Pinpoint, mark, and trace out any lines that are located.

In most, but not all areas, radio mode will locate lines that do not radiate power signals and a grid search should be made in both power and radio modes.

### 7.5.2 Inductive search

An inductive search procedure is the most certain technique for locating unknown lines. This type of search requires a transmitter and receiver and two people. This type of search is referred to as a 'two person sweep'. Before starting the sweep, define the area of search and the probable direction of lines crossing the area. Ensure the transmitter is switched on in induction mode.

**NOTE:** On receivers and transmitters that feature iLOC, this process can be completed by a single operator providing the receiver and transmitter are within 800m (880 yards) line of sight.

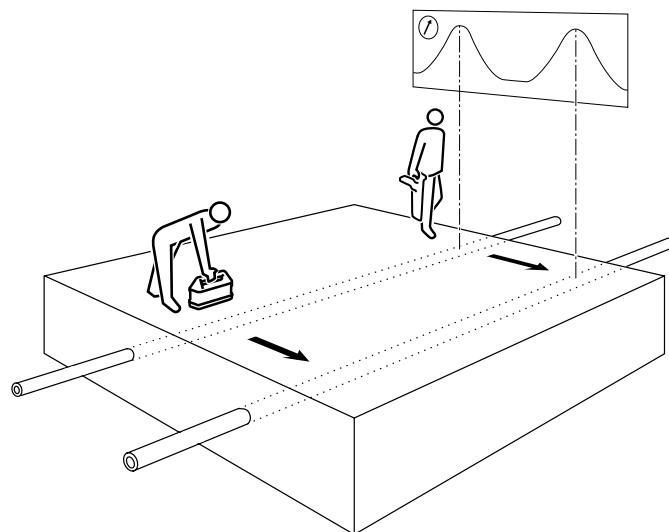

Figure 7.5: Inductive search

The first person operates the transmitter and the second person operates the receiver. The transmitter induces a signal onto lines as it passes over them and the lines are then detected with the receiver 20 paces upstream or downstream of the transmitter. Hold the transmitter with its length aligned with the assumed direction of any lines.

The second person holds the receiver at the start of the area to be searched and with the receiver antennae at right angles to the probable direction of the buried lines. Set the receiver sensitivity level as high as possible without the receiver picking up any airborne signals directly from the transmitter.

When the transmitter and receiver are in line both operators start to move forward in parallel. The operator with the receiver sweeps it backwards and forwards, keeping the receiver vertical, as they proceed in parallel with the transmitter. This method allows for misalignment of the transmitter, receiver and buried line.

The transmitter applies the strongest signal to the lines directly below it, which are then located with the receiver. Move the transmitter from side to side to establish the highest signal which indicates that the transmitter is also directly above the line(s).

Mark the ground at the point of each peak signal detected with the receiver. Repeat the search along any other possible paths of lines.

Once the positions of any lines have been marked, reverse positions, place the transmitter over and along each line in turn, and trace the line out of the search area.

# Section 8. – Depth and current readings

## 8.1 Depth readings

The RD8000 can measure the depth of buried conductors down to depths of approximately 6 meters (20 feet). The depth measurement is to the center of the pipe or cable. The best readings are detected from signals outputted by a transmitter rather than from passive sources.

The RD8000 is capable of determining depth when locating passive power signals. However passive signals on lines are less suited for measuring depth because accuracy is questionable due to the passive signal being present on more than one line.

**NOTE:** The accuracy of depth measurement is subject to a number of factors and is meant as a guide only. Exercise caution when performing any excavation.

**WARNING!** Do not make depth measurements near bends or tees in the line. Go at least 5 meters from a bend for best accuracy.

### 8.1.1 TruDepth and Compass

It is important to note that the RD8000 will only display depth when the receiver is correctly oriented above the target line, cable or sonde. To ensure the receiver is correctly oriented, use the LCD Compass.

When locating lines, make sure the Compass displays the line in the 6 o'clock position.

When locating sondes (see Section 10.4), make sure the Compass displays the line in the East / West position.

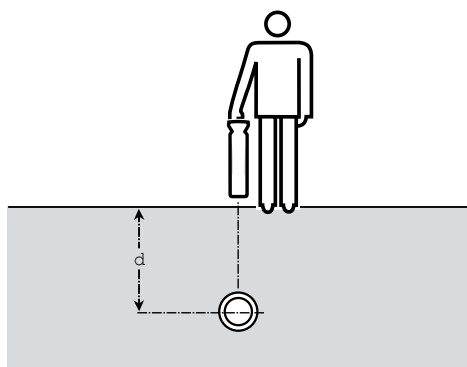
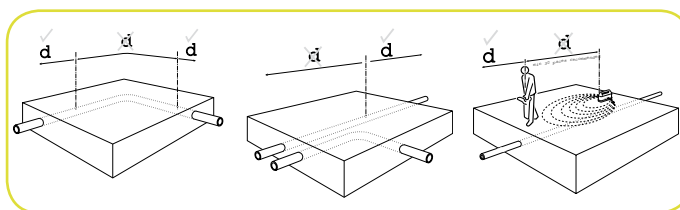

Figure 8.1: Taking a depth reading

To avoid signal distortion, do not apply the signal by induction. If direct connection or signal clamping is not possible, place the transmitter at least 15 meters from the point of any depth measurements.

Depth measurements are not accurate if there is audible interference or if part of the transmitter signal has coupled to a nearby line.

Confirming the peak position coincides with a null position indicates that the position is suitable for making a depth estimate.



Figures 8.2: Depth readings

- Pinpoint the target line accurately with the receiver.
- Check the receiver is directly over the line, the antennae are at right angles to it and the receiver is vertical. Adjust sensitivity level to bring the bar graph indication on scale.
- Press the depth button to alternate between depth and current readings.

If the ground appears to radiate a strong field, perhaps near a radio station, check depth by holding the bottom of the antenna 50mm above the ground and subtract this reading from the indicated depth.

## 8.2 Verifying depth measurements

Check a suspect or critical depth reading by lifting the receiver 50mm (2 inches) above the ground and repeating the measurement. If the measured depth increases by the same amount it is a good indication that the depth reading is correct.

Depth measurements should be accurate to  $\pm 2.5\%$  if conditions are suitable. However, you may not always know if the conditions are suitable so the following techniques should be used to check critical readings:

- Check that the route of the line is straight for at least 2 meters (6'6") to either side of the measurement point.
- Check that the signal response is reasonably constant over the 15 meter distance to the transmitter and make depth measurements to either side of the original point.
- Check that there are no adjacent lines carrying a significant signal within 1 to 2 meters of the target line. This is the most common source of error of depth measurements as a strong signal coupled to an adjacent line can often introduce  $\pm 50\%$  error.
- Make several depth measurements at points slightly displaced from the line's apparent position. The shallowest indication will be the most accurate and will also indicate the line's position most accurately.

### 8.2.1 Rough depth calibration check

This check is a quick and easy way of verifying that the depth reading on the receiver is within acceptable limits. It can be used if you are getting inaccurate depth readings from a cable or pipe for which you know the approximate depth. Inaccurate depth readings could be the result of the receiver picking up a stronger signal such as another cable or pipe running in close parallel to the target pipe or cable.

There are two ways of checking the calibration of the receiver in the field. Both methods require the use of a transmitter:

#### Method 1

Place the transmitter on top of a non-metallic object, such as a cardboard box, on the ground and away from any buried lines. Switch the transmitter on, ensuring that no accessories are connected and that the transmitter is in induction mode. To reduce the effects of ground coupling the transmitter, when it is placed on the box, must be more than 500mm above the ground

Hold the receiver with the blade horizontal and pointing

towards the front of the transmitter and approximately five meters from the front of the transmitter.

1. Switch the receiver on.
2. Select the same induction frequency as is selected on the transmitter.
3. Select sonde mode on the receiver.
4. Move the receiver from left to right and when the maximum signal is obtained place the receiver on top of a non-metallic object, such as a cardboard box, on the ground. Ensure that the blade is horizontal and pointing towards the transmitter. To reduce the effects of ground coupling the receiver must be more than 500mm (18 inches) above the ground when it is placed on the box.
5. Note the depth as indicated on the receiver LCD.
6. Measure the distance from the base of the receiver to the center of the transmitter using a tape measure.
7. Compare this reading with the depth reading on the receiver.

The receiver can be considered accurate if the difference between the depth reading on the receiver and the distance measured with the tape is less than 10%.

#### Method 2.

1. Apply a signal to a cable or pipe of known depth.
2. Locate the cable or pipe; the receiver will display depth on the LCD automatically.
3. Compare the depth reading on the receiver with the actual depth.

## 8.3 Current readings

### 8.3.1 Identification using current measurements

Measuring current value on a line helps confirm the identity of the line and provides information about the condition of cable insulation or pipe coating.

### 8.3.2 About current measurements

The transmitter applies a signal or current onto a target line. The current decreases in strength as the distance from the transmitter increases. This rate of decrease depends on the type of line and on soil conditions. Regardless of the type of line and the frequency being used the rate of decrease should be regular with no sudden drops or changes. Any sudden or abrupt current change indicates that the line or its condition has changed.

In congested areas, where there is more than one line, the receiver may sometimes detect a stronger signal from an adjacent line to which the signal has coupled or shares common grounding because it is nearer the surface. Although current measurement compensates for depth, signal response will be less as the depth increases.

The line with the highest current measurement, rather than the line giving the strongest response, is the target line to which the transmitter signal has been applied.

Measuring current provides useful information about the position of bends and intersections. Measuring current after a tee will indicate the main line that pulls more current along its greater length.

Figures 8.4 – 8.6: Taking current readings

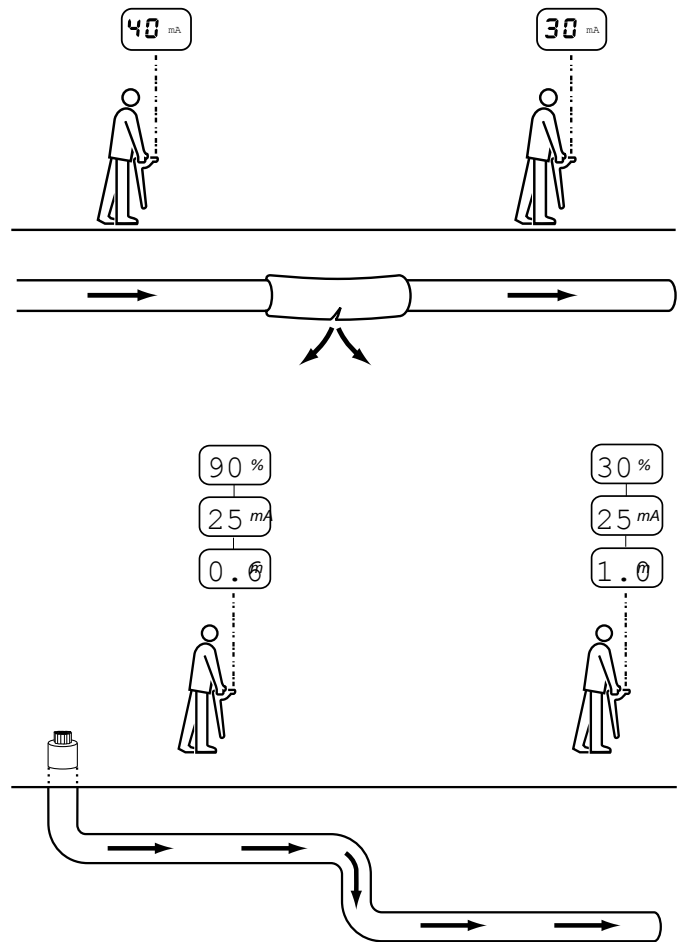
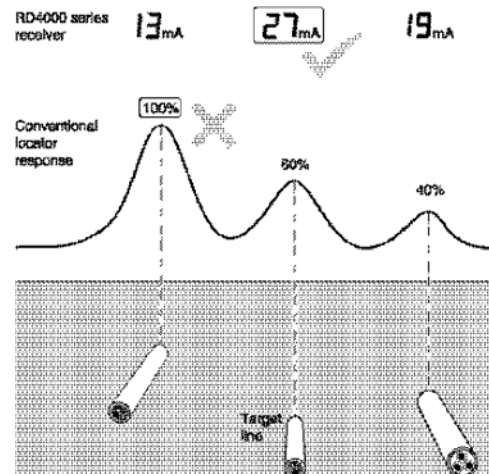
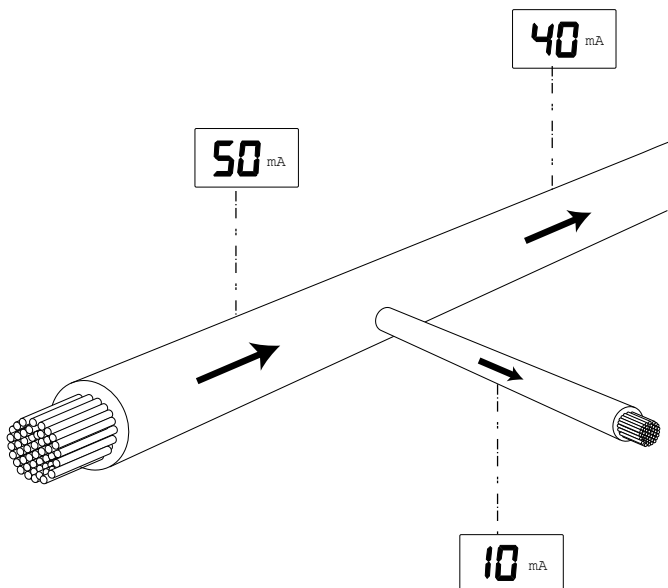

Figure 8.3: Current readings





### 8.2.3 Applying a transmitter signal

The transmitter signal can be connected, clamped or induced to the target line in the same way as the signal for line tracing is applied.

### 8.2.4 Signal current measurements

Pinpoint the line and confirm the accuracy of the peak pinpoint with a null pinpoint. Check the receiver is directly over the line, with the antennae at right angles to it and vertical.

The receiver will automatically estimate and display depth on the LCD.

A signal coupled to a nearby line may distort the accuracy of the measurement. If the accuracy of the reading is suspect, sweep the area to check if other nearby lines are radiating the signal. If other signals are causing interference, it may be necessary to make the current measurement at another point along the line.

Both antennae are needed to make a current measurement and receiver accessory antennae such as a normal clamp or stethoscope cannot be used. Because current measurement is a function of depth, it is only available in the locating modes. It is also available with Current Direction (CD) clamps.

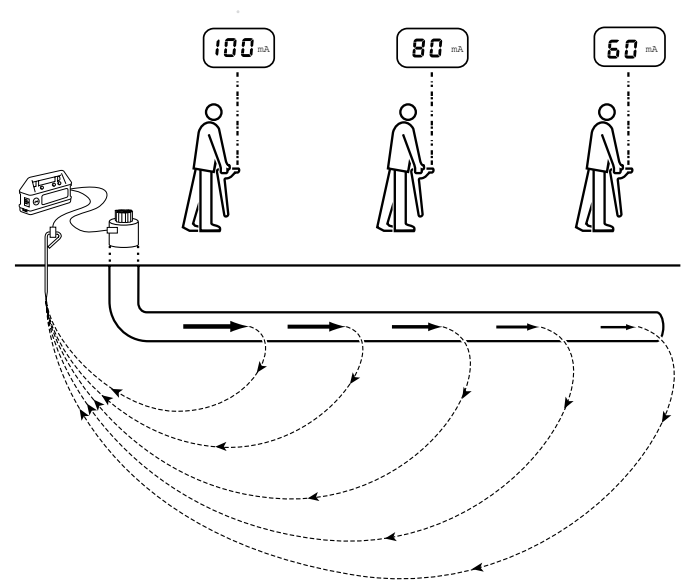

**Figure 8.7: Current readings using transmitter signals**

# Section 9. – General Locating tips

## 9.1 Eliminating services

### 9.1.1 Induction

If several conductors are running parallel and it is not possible to connect a transmitter, each line may be located separately. Proceed as follows:

1. Perform a sweep of the area to find the position and number of conductors in the area.
2. Map the direction in which the conductors are going.

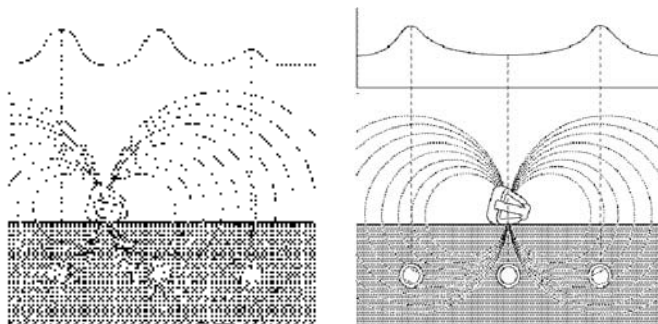

Figures 9.1 – 9.4: Interference from services

### To trace the lines:

1. Select induction mode on the transmitter.
2. Select the same frequency as on the receiver.
3. Place the transmitter on its side and in line with a conductor.
4. Ensure the conductor is directly below the transmitter.
5. This will null the signal directly below the transmitter and, in addition, enable the other conductors to be located.
6. Locate each conductor and mark its position.
7. Move the transmitter down the route and continue locating and marking.
8. Trace each conductor out of the search area until the target line can be accurately located.

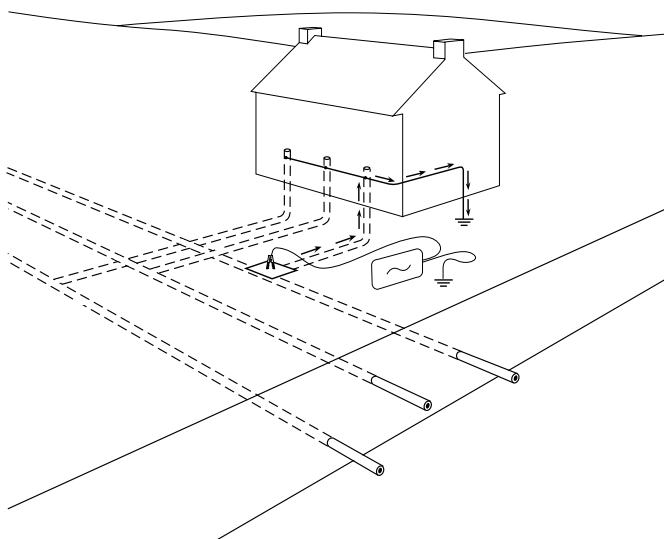

### 9.1.1 Unwanted signal coupling

Unwanted coupling of the signal from the target line to another nearby line is one of the most common location problems. It leads either to an error in the marked position and depth of the target line or to marking the wrong line. A certain degree of coupling is unavoidable in many situations but there are ways in which a careful user can reduce coupling and increase location reliability.

- Avoid applying the signal by induction. The signal may be coupling to more than one line directly from the transmitter. Use the signal clamp where possible.

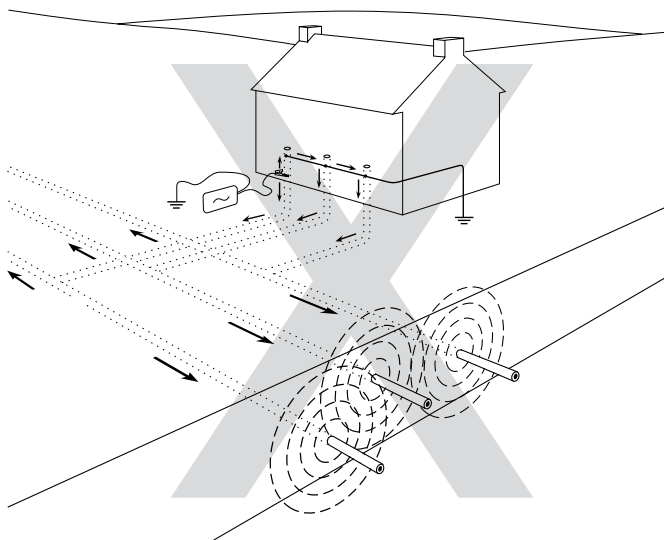

- Identify points where lines may be bonded or in close proximity to each other. Work toward these points rather than away from them. For example, if gas and water pipes are bonded within a building, apply the signal at the valves or access points in the road rather than in the building.
- Reduce coupling to a parallel line by using a low signal frequency where available.
- Return signal flowing on another line. Use a double-ended connection to by-pass the ground return if possible.
- Choose a signal application point where the line is furthest from other lines and not in a congested area.
- When using single-ended connection, site the ground stake as far from the target line as possible and away from other buried lines.
- Avoid using existing structures for ground connections; other buried lines may be bonded to them.

A bad ground connection or just laying the ground lead on the surface at right angles to the line may result in less coupling than a good ground provided long distance tracing is not required.

## 9.2 Signal grounding

### 9.2.1 Manhole covers

Sometimes when locating, it is not possible to insert the ground stake into the earth, for example, when locating on hard ground such as roads. In this case, the ground return can be made by attaching the ground lead to the metal frame of a manhole.

### 9.2.2 Using lighting columns

Direct connecting to a metal, street-lamp column is almost as effective as connecting to the cable sheath itself. Normally the cable sheath is bonded to the metal column, therefore a simple connection onto the column enables the user to locate the street lighting quickly and safely without having to call out a technician from the lighting company.

If the lighting column is made from concrete make the transmitter connection to the cable sheath unless the cable is earthed to the inspection doorframe. Connection to the cable sheath applies the transmitter signal for a considerable distance enabling the receiver to trace cables feeding illuminated street furniture as well as other street lights.

**⚠ WARNING! The live cable connector is for use only by operators licensed or permitted to work on live cables.**

When the cable is not grounded at the column, open the inspection door and connect the live cable connector to the live or neutral conductor.

The use of a street light column as a means of applying a signal to other power cables on the same electric circuit is a possibility. The signal may be weak using this method because it may have travelled some distance back to the sub-station and out again on the other system. With the receiver used on a high sensitivity setting it is often possible to locate a cable, which would otherwise have been difficult or inconvenient to energize with the transmitter signal.

### 9.2.3 Finding a good ground point

When using a direct connection, it is important to get the best possible grounding for the transmitter. This provides the lowest resistance ground path and the best output signal. If it is not possible to use the ground stake the following are examples of good alternative ground points:

- Metal manhole covers.
- Metal drainage grates.
- Metal railings.
- Metal fence posts.

## 9.3 Double-ended connections

Large diameter water pipes and gas distribution pipes that are laid in sections sometimes have insulated joints between the sections and can be difficult to locate using a single ended connect. This is because when using a single ended connection ground return, signals can often cause confusion by returning to the transmitter along other lines. The problem sometimes occurs when return signals appear stronger than on the target line, usually because the target line is deeper than the line carrying the return signal, or the return path may be a better electrical conductor than the target line.

Applying a double-ended transmitter connection is a useful technique for positively tracing and identifying a target line in a situation such as a heavily congested industrial site, provided there are access points at each end of the line.

### 9.3.1 Making a double-ended connection

Connect the transmitter to an access point on the target line. The transmitter ground is connected with a long cable to another access point further along the line. A complete circuit is achieved without using ground as a current return path. The long cable should be kept as far away as possible from the expected route of the line. Radiodetection supplies 50 meter and 200 meter extension cables for this purpose.

This method of applying the transmitter signal is ideal for positive identification of a target line. When a connection has been made to two points on the same line, the same level of current should be detectable all round the circuit. The receiver display should remain constant if the depth of the line does not change.

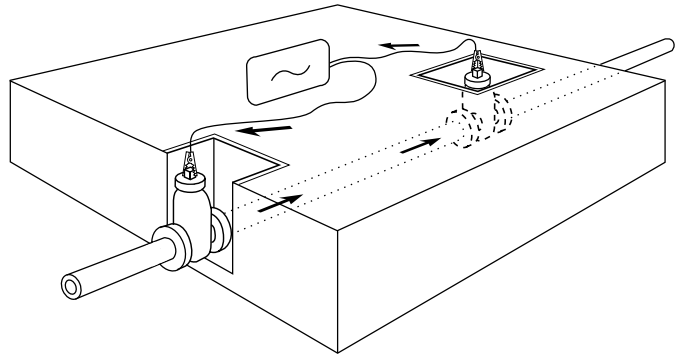

Figure 9.5: Making double-ended connections

# Section 10. – Using Accessories

## 10.1 About accessories

Both the transmitter and receiver are compatible with a wide range of accessories, including most RD4000 accessories. Use clamps to help apply a signal to pipeline or live wire. Use an A-Frame to provide the RD8000 receiver with advanced fault-finding capabilities.

When an accessory is connected, the receiver or transmitter will instantly recognize it and will enable the mode appropriate to the accessory. For example, attaching an A-Frame to the RD8000 receiver will automatically switch the receiver to fault-find mode and limit the number of available frequencies to those that are compatible with the A-Frame. The LCD will also display an icon of the accessory and will remove any non-essential icons from the screen.

For a full list of supported accessories, please refer to Appendix 13.6

## 10.2 Receiver clamps

A receiver clamp is used to positively locate and identify a cable when several cables are running close together.

A target cable can be identified in a chamber, on a tray or other access point by fitting a clamp to the receiver and examining each cable in turn. Signal strength response shown on the receiver display should be noted for each cable.

### 10.2.1 When to use clamps

Clamps can be used where:

- Several cables or pipes run in close proximity to each other.
- A cable or pipe is accessible at an inspection hole or manhole.

**Note:** The standard clamp cannot be used with CM or CD. A special CM/CD clamp is available.

### 10.2.2 Connecting a clamp

1. Put the clamp connector into the accessory socket on the front of the RD8000 receiver.
2. Place the clamp around the pipe or cable and switch the receiver on.
3. Set the frequency to the same as that on the transmitter.
4. Put the clamp around each cable in turn and note the bar graph response. Compare the strength of response from each cable. The cable with a substantially stronger response than the others will be the cable to which the transmitter signal has been applied.

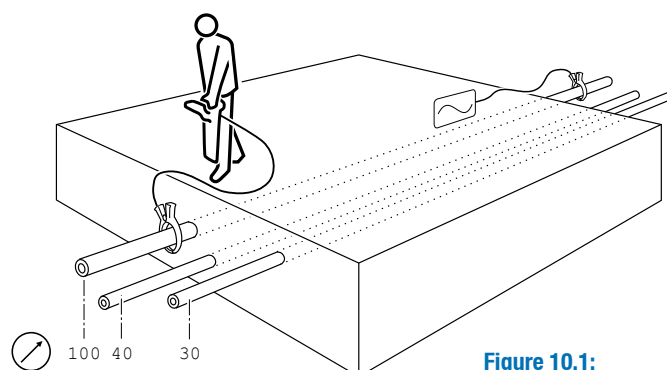

**Figure 10.1:**  
Connecting clamps

To ensure that the target cable has been correctly identified, reverse the positions of the transmitter and receiver and check that the strongest response is still received from the target cable by the receiver in its new position.

## 10.2.3 Available receiver clamps

### Standard clamp

The clamp plugs into the receiver accessory socket and is used for cable identification at points where the cable can be accessed. The standard clamp is suitable for cables up to 100mm (4 inches) diameter.

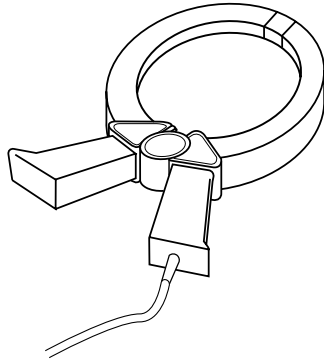

Figure 10.2:  
Standard clamp

### Small clamp

The small clamp performs the same function as the standard clamp but is useful in cramped situations where there is insufficient access for the standard clamp.

The small clamp is suitable for cables up to 50mm diameter.

### Current Direction (CD) and Current Measurement (CM) clamp

The CD/CM clamp plugs into the accessory socket of the receiver and enables CD and CM measurements to be made on individual cables.

## 10.3 Transmitter clamps

The transmitter clamp fits around a pipe or cable and safely applies a signal to a live cable without interrupting or disconnecting the supply. The clamp applies a very discriminating signal to a target line with reduced coupling to other lines. A clamp can sometimes be a more effective method of applying the signal than direct connection.

The target line will carry the strongest signal. The other lines will carry the weaker return signal. If the system comprises only two conductors, they may carry equal signals.

**⚠ WARNING!** When clamping around a power cable ensure that the clamp is connected to the transmitter at all times.

The clamp may buzz or vibrate if it is placed around a power cable that has significant net current flow. This is normal and does not harm the equipment.

### 10.3.1 Connecting the clamp

Plug the clamp into the transmitter output socket.

Put the clamp around the pipe or cable and ensure that the jaws are closed. Switch the transmitter on.

The line should be grounded (earthed) on each side of the clamp for the signal to transfer to the line. Ground the line if necessary. An insulated cable may be traced even if it has no actual ground connection, providing a reasonable length is buried either side of the clamp to provide capacitive coupling to ground (earth).

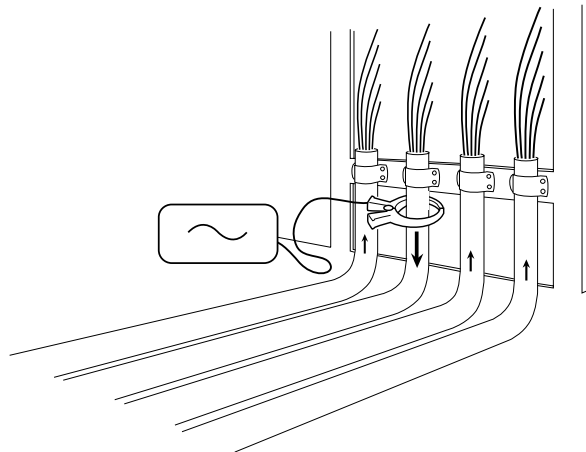
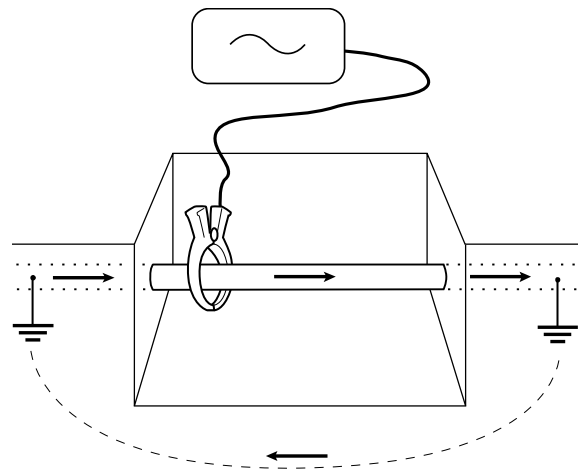

Figures 10.3 – 10.4:  
Connecting transmitter  
clamps

**NOTE:** It is not necessary to make a ground connection from the transmitter when using the clamp.

### 10.3.2 Available transmitter clamps

Although transmitter and receiver clamps look the same, they have different internal windings. To prevent the wrong clamp being connected, transmitters and receiver clamps have plugs of a different orientation.

#### Standard signal clamp

The standard clamp applies the transmitter signal very selectively and effectively to a target cable up to 100mm diameter at 8/33kHz frequency or up to 75mm diameter cable at 512Hz.

The standard and small clamps have a double spring action for positive toroidal contact.

#### Small signal clamp

The small signal clamp is useful for applying an 8kHz and 33kHz signal to a target cable in a pedestal or other place with limited space. The clamp is suitable for cables up to 50mm diameter.

#### Current Direction (CD) and Current Measurement (CM) clamp

The CD/CM clamp plugged into the accessory socket of the transmitter enables CD and CM signals to be applied to individual cables.

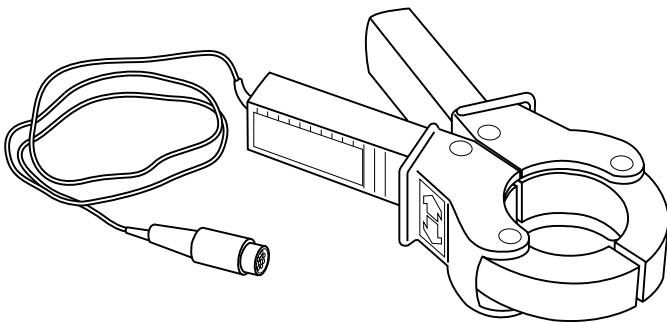

Figure 11.5 CD clamp

**⚠ WARNING!. The transmitter must only be connected to live services using the appropriate accessory such as a plug connector or live cable connector.**

## 10.4 Sondes

### 10.4.1 When to use a sonde

A sonde transmitter is a small battery powered signal transmitter that can be inserted into non-metallic ducts, drains or sewers so they can be located and traced with a receiver. A wide range of transmitting sondes is available to suit different applications. Sondes can also be used to pinpoint joints in iron gas pipes, locate blockages in plastic water pipes and monitor the progress of horizontal boring tools.

### 10.4.2 Choosing a suitable sonde

Check that the sonde has sufficient range for the application and is dimensionally small enough and sufficiently robust for the application. Ensure that the frequency of the sonde corresponds with the receiver frequency; the receiver will not locate the sonde unless the frequencies are the same. Sondes are marked with their transmitting frequency. Ensure that the means of propelling the sonde is available together with the correct fittings and couplings.

### 10.4.3 Preparation

Insert a new battery into the sonde. A new battery or a freshly recharged battery should be used at the beginning of each day and preferably at the start of each new job.

Before inserting the sonde, check that the sonde and receiver are at the same frequency and working correctly. To do this, place the sonde on the ground at a distance from the receiver that is equal to the rated depth of the sonde. Point the receiver at the sonde with the antenna in line with the sonde (the opposite of using the receiver to locate a line) and check that the bar graph reading exceeds 50% at maximum sensitivity.

### 10.4.4 Propelling a sonde

Sondes have a male thread at one end for connecting to drain rods, or to other devices for inserting and propelling the sonde along a drain or duct. Sondes may be floated along drains at the end of a tether and floats are available for fitting to the sewer sonde and super sonde. Sondes can be strapped to high-pressure water jets or similar devices used for cleaning, maintaining and inspecting drains. Sondes used in underground drilling and boring operations are normally housed in the boring or drill head behind the boring or drill bit.

## 10.4.5 Locating and tracing a sonde

Insert the sonde in the drain or duct access and locate it while it is still just in view at the drain or duct entrance. Hold the receiver vertical directly over the sonde with the antenna in line with the sonde. Adjust the receiver sensitivity so the bar graph reads between 60% and 80%.

The sonde radiates a peak field from the center of its axis with a ghost signal at each end of the peak. Move the receiver a little way behind and then in front of the axis of the sonde to detect the ghost signals. Finding the two ghost signals positively confirms the locate. Reduce the receiver sensitivity to lose the ghost signals but still indicate a clear peak response directly over the sonde. Receiver sensitivity is now set for tracing the duct or drain unless the distance between sonde and receiver changes.

Propel the sonde three paces along the drain or duct and stop. Place the receiver over the supposed position of the sonde. Do not adjust the sensitivity level.

### To locate a sonde:

1. Move the receiver backwards and forwards and stop when the bar graph indicates a peak. You can use the LCD compass to orient the blade of the receiver with the direction of the sonde.
2. Rotate the receiver as if the blade is a pivot. Stop when the bar graph indicates a peak.
3. Move the receiver from side to side until the bar graph indicates a peak.
4. Repeat 1, 2 and 3 with the antenna vertical and resting on or just above the ground. The receiver should then be directly above the sonde with the antenna inline with it. Mark the position of the sonde and its direction.
5. Propel the sonde a further 1 or 2 meters, pinpoint, and mark the position. Repeat this pinpoint procedure at similar intervals along the line of the drain or duct until the survey is completed.

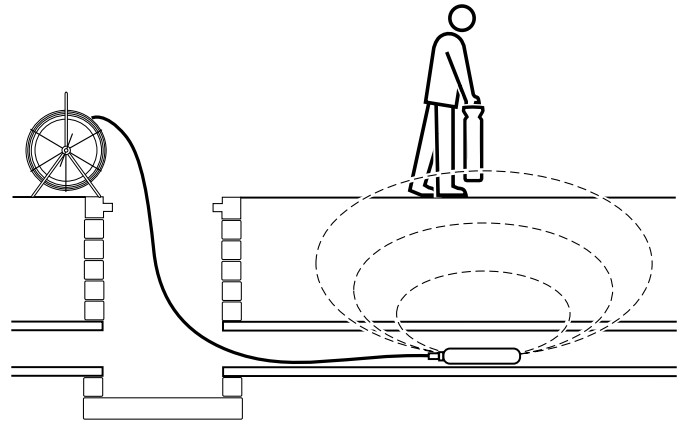

Figure 10.6: Sonde deployment

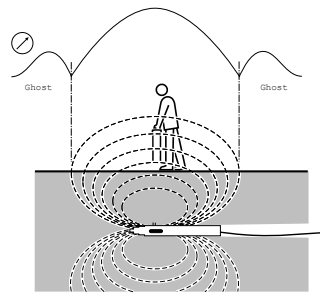

Figure 10.7: Locating a sonde

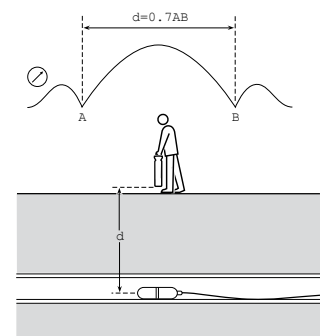

Figure 10.8: Calculating sonde depth

## 10.4.6 Checking sonde depth

The RD8000 receiver will automatically display the depth of a located sonde providing the receiver is correctly oriented and positioned above the sonde. Using the LCD compass as a guide, rotate the receiver until the compass indicates the sonde is in East/West position.

### Calculation method

Pinpoint the sonde. Move the receiver in front of the sonde and still with the antenna in line with it, increase sensitivity to find the peak of the ghost signal. Move the receiver to behind the sonde ensuring that the receiver blade is always in line with the sonde. Find the null positions A and B (See Figure 10.8). Measure the distance between them and multiply by 0.7 to give an approximate depth measurement.



## 10.4.7 Types and range of sondes

### Standard sonde

The standard sonde combines compact size with a strong signal and is the standard sonde for most applications unless a smaller size, greater depth or rugged construction sonde is required.

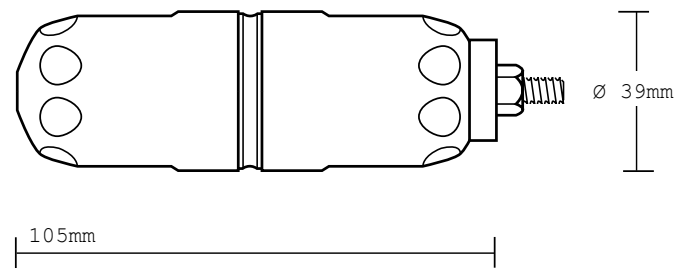

Figure 10.9: Standard sonde

### Super small sonde

This is a specialized sonde particularly suitable for no-dig applications. This type of sonde has an interchangeable battery compartment so that the length of the sonde can be altered. Shortening the length of the sonde means that fewer batteries can be accommodated and this will affect battery life.

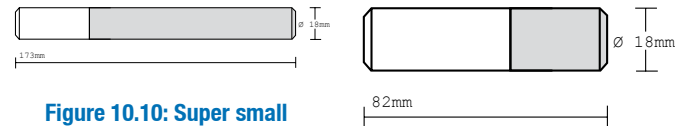

Figure 10.10: Super small sondes

### Sewer sonde

This sonde incorporates a very strong housing and makes the sonde suitable for use in municipal sewer systems. The sonde has a long life for daily use in all conditions.

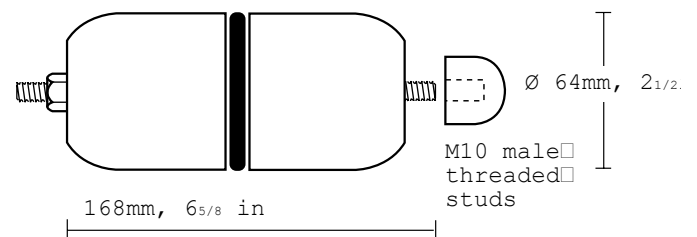

Figure 10.11: Sewer sonde

### Super sonde

A particularly rugged sonde for use in deep sewers.

### FlexiTrace

The FlexiTrace is a traceable plastic covered fiberglass rod incorporating wire conductors and is used for locating small diameter, non-metallic pipes to a depth of to 3 meters. The FlexiTrace can be inserted into a pipe or duct as small as 12 mm/0.5 inch internal diameter with a minimum bend radius of 250mm. Batteries are not required, as the FlexiTrace is powered by the RD8000 transmitter.

The FlexiTrace can be used in two modes: Sonde mode or Line mode. In sonde mode only the tip of the FlexiTrace is energized whilst in line mode its whole length is energized.

To use as a sonde, connect both transmitter leads to the FlexiTrace stud terminals. As the FlexiTrace terminals are not color coded it does not matter to which terminals the leads are connected. To use the FlexiTrace in line mode, connect the red transmitter lead to a FlexiTrace terminal and ground the black lead.

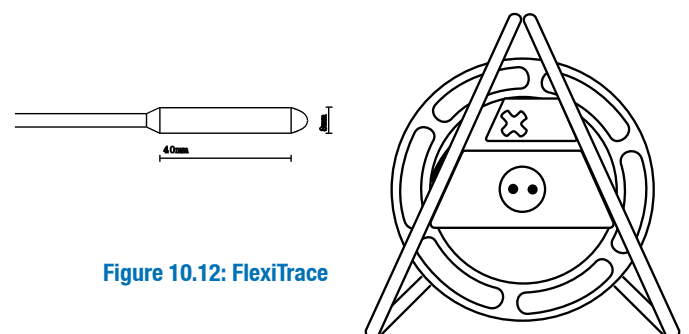

Figure 10.12: FlexiTrace

## 10.5 Stethoscopes

### 10.5.1 When to use a stethoscope

At times, it may not be possible to put a clamp around a cable because of congestion or because of inaccessibility. A stethoscope antenna should be used in the place of the clamp to identify cables.

### 10.5.2 How to use a stethoscope

Plug the stethoscope into the receiver accessory socket. Press the concave head against each cable in turn to detect a maximum signal.

### 10.5.3 Types of stethoscope

#### Large stethoscope antenna

The large stethoscope antenna, which plugs into the receiver accessory socket, is used for cable identification in situations where the cable is exposed. It is particularly useful for identifying heavy cables lying in a tray where it is not possible to fit a clamp. The concave detector head on the end of the insulated, flexible gooseneck is placed firmly against the cable to be identified. If there are a number of cables, the stethoscope antenna will give the strongest response from the cable to which the transmitter signal has been applied.

#### Small stethoscope antenna

The small stethoscope antenna has a 25mm concave head at the end of a 2m lead. The small stethoscope can be screwed into an extension rod or used at the end of several extension rods joined together for identifying inaccessible small cables.

#### Miniature hi-gain stethoscope

The miniature stethoscope is similar to the small stethoscope but has no handle or facility for extension rods.

The miniature stethoscope can also be used as a miniature antenna for locations where the bulk of the receiver makes it inconvenient for use, such as locating pipes or cables in walls.

#### CD stethoscope

In restricted areas, the CD stethoscope can be used to obtain current direction but not current measurement.

## 10.6 Submersible antenna

### 10.6.1 When to use a submersible antenna

Tracing buried pipes and cables across waterways and estuaries are frequent and critical locating applications. Less frequent but equally important is tracing and locating lines between the mainland and offshore islands. When locating pipes and cables the receiver sensing antennae should be as close as possible to the target line so it is not practical to locate lines buried under a river or seabed from the surface. In most cases, it is necessary to measure the depth of cover to ensure the line is protected from dragging anchors or other underwater hazards.

The submersible, double depth antenna is suitable for use under water for tracing pipes or cables. There is a weight at the bottom of the antenna for stability and the unit has been pressure tested to IP68 to a depth of 100m.

The antenna is supplied with 10m of submersible marine umbilical cable as standard, but lengths of up to 100m can be supplied. The extra length enables the antenna to be carried by a diver on a riverbed or seabed while the receiver is used in a surface vessel. It is crucial to have effective communication between the operator with the receiver and the diver with the antenna.

Alternatively the antenna can be fastened to the end of a non-metallic boom from a barge and lowered to the riverbed or seabed.

### 10.6.2 How to use a submersible antenna

Apply the transmitter signal to the target line at an access point on the shore. The submersible antenna line for tracing the line underwater is plugged into the accessory socket of the receiver. The receiver is used onboard a boat, which should be positioned directly over the line. The transmitting signal should be by direct connection with the strongest possible signal and a low frequency (less than 1kHz). Make a ground connection about 50m from the transmitter. Test the quality of signal on the line before locating on the water.

**Note:** The submersible antenna is calibrated to work at one frequency.

## Tips for using a submersible antenna

The user in the boat should be a specialist or have considerable experience using a receiver so that they can give concise instructions to the diver.

It is prudent for the pair to practice working together on dry land before attempting to locate underwater. Using the antenna the diver should locate and trace a known line blindfolded receiving directions from the user with the receiver out of sight of the line and the diver.

Because of rapid signal loss and a combination of large surface area and very conductive soil there may be problems applying a suitable signal for tracing a large diameter pipe. It may be necessary to use a high power, low frequency tracing signal.

It is necessary to define a method of recording target line position and depth before starting work in the boat or on the seabed.

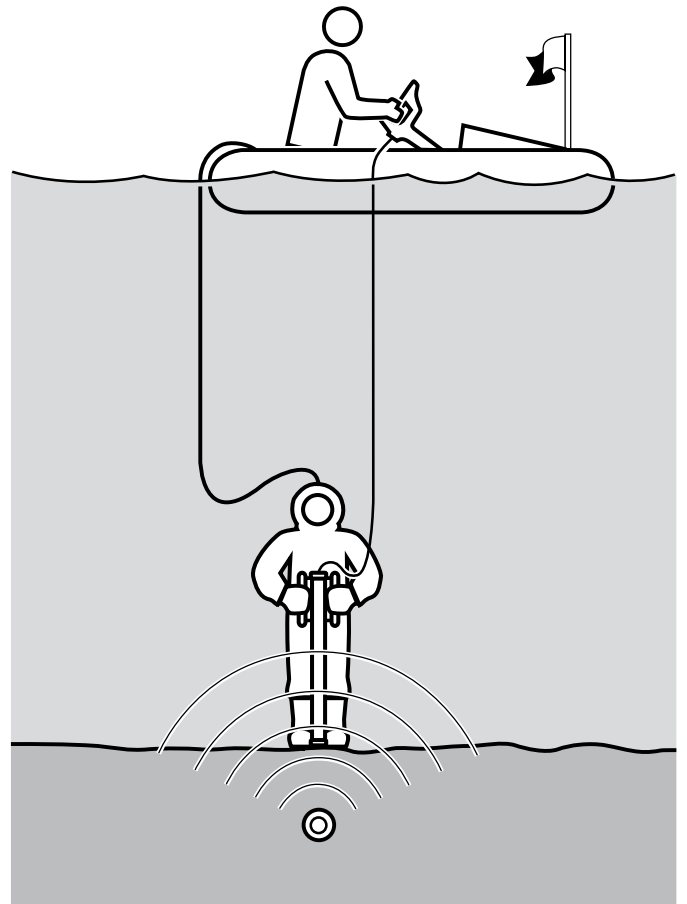

**Figure 10.13: Using a submersible antenna**

# Section 11. – Fault-Finding

## 11.1 About fault-finding

The RD8000PDL and PDLB are capable of locating cable to ground faults caused by damaged cable sheaths. This process is known as 8K Fault-Finding as it uses an 8kHz signal applied to a target line with a transmitter.

The accessory A-frame is used to locate cable sheath faults on power and telecom cables. To use Fault-Find you will need the following equipment:

- RD8000 receiver
- Tx3 or Tx10 transmitter
- Accessory A-frame connection leads.

## 11.2 Preparation

Using RD8000 standard locating techniques locate the cable for a short distance and trace and mark its route. Remove all earth bonds from the line to be traced during the fault-finding survey.

### 11.2.1 Connecting the transmitter

1. Switch the transmitter off.
2. Push the connector plug into the transmitter accessory socket.
3. Clip the red connection lead to the cable or cable sheath ensuring that the area around the connection is clean.
4. Extend the black connection lead as far away as possible and at 90° to the probable route of the target cable and clip the connector to the ground stake.

**NOTE:** Always connect the black connection lead to a ground stake and not a water pipe or buried cable, as these may carry the signal.

### 11.2.2 Reference readings





It is good practice to obtain a reference reading from the ground stake before you attempt to locate a fault on a target line. Reference readings help to provide the following information:

- Severity of fault.
- Survey interval.

Before taking the reference reading set up the transmitter and receiver as follows:

#### On the transmitter:





1. Switch the transmitter on by pressing the  key.
2. Select a fault-finding frequency using the  key.
3. Use the  or  arrows to increase or decrease the 8kHz power output level.
4. If required you can use the BOOST setting if the fault is located on a high resistance cable or if the cable is long.

**WARNING!** By selecting 8kHz output a high voltage warning icon will appear on the transmitter's LCD.

Move to the next step of the procedure.



#### On the receiver:

1. Switch the receiver on by pressing the  key.
2. Connect one end of the connection lead to the A-frame socket.
3. Connect the other end to the receiver accessory socket.
4. The receiver will automatically recognize the A-frame and display the A-frame icon on the LCD.
5. Select a fault-finding frequency using the  key.

**NOTE:** If the receiver and transmitter are iLOC enabled then you can remotely control the transmitter using the receiver. See Section 6 for more information.

#### Obtaining a reference reading:

Position the receiver approximately 2m (6 feet) from the ground stake and push the A-frame spikes into the ground with the green spike towards the ground stake

Attach the receiver to the A-frame by the retention hook. (If you are holding the receiver separately, make sure that the receiver is in line with the A-frame and is pointing towards the green spike.) The fault direction arrow should

be pointing away from the ground stake. If it is not, make sure that the transmitter is connected correctly (red connector to the cable and black to the ground stake)

Take the dB reading and keep it for reference. If there is a single fault on the cable, it will be approximately the same dB value as the reference reading.

**NOTE.** To establish how often to take readings on the cable, move away from the ground stake and take further readings until the arrow has difficulty in locking and the dB reading is low. Measure the distance that the receiver is now away from the ground stake. This is the distance that you can safely use between taking readings on the cable to ensure that you do not miss the fault.

### 11.3 How to find a fault

Starting from the transmitter, walk along the cable route pushing the A-Frame spikes into the ground with the green spike pointing away from the transmitter. Where there are no faults the dB reading will be low and the direction arrow may flicker forward and back.

**NOTE:** Flickering arrows may also indicate that you may be too far away from the fault or ground stake (or both) for the receiver to lock on.

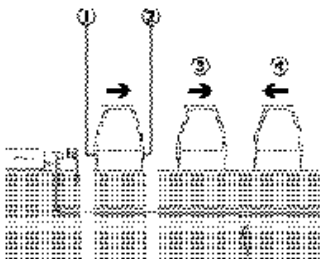

Figure 11.1: Cable sheath fault-finding

If you are trying to locate high resistance faults or there is a long distance between faults, carry on with the survey and the receiver will lock on when you get closer to the fault.

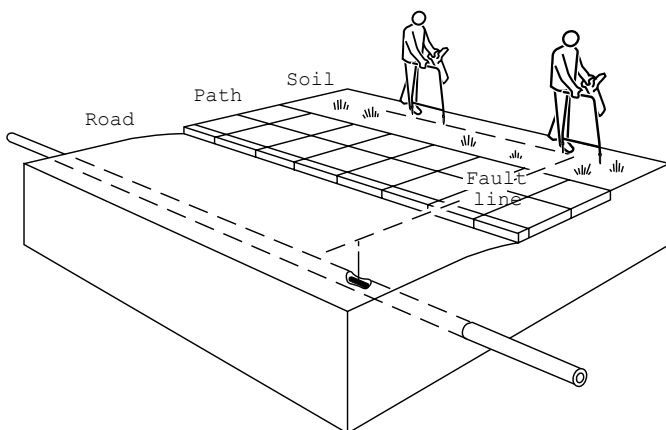



Figure 11.2: Locating cable sheath faults with the receiver and A-frame

Take readings at the survey intervals determined by the reference reading. To locate the cable during a Fault-Find survey, press the  key once and the receiver will switch to 8kHz null mode. Locate the cable using the normal null mode technique. Press the  key again to return to Fault-Find mode.

As a fault is approached the Fault-Find direction arrow will lock on to the fault signal and point forward and the dB readings will increase. When the fault is passed the arrow will point back towards the transmitter. Take readings at smaller survey intervals to determine the exact point of the fault.

When the A-frame is directly over the fault the dB reading will drop as shown opposite.

**NOTE:** The values given are for illustration purposes only and may not be the same as those obtained in other situations.

To pinpoint the fault, turn the A-frame 90° to the cable and Fault-Find until the exact point is found where the arrow direction changes. The center line of the A-frame is now directly over the fault.

Mark the ground to show the position of the fault. Find the maximum dB reading in front of the fault by pushing the A-frame into the ground at small intervals. Note the dB reading. If the reading is approximately the same as the reference reading, you can assume that there is only one fault. If the reading is less than the reference reading, keep surveying the cable for other faults.

Replace the bonds between the sheath and ground at each end of the line once the fault-finding survey has been completed.

**NOTE:** If the cable runs under a road, use the equipment as normal on the road surface as it can sometimes detect signals when working on blacktop, concrete, or paved surfaces. If necessary, try wetting the road surface. Pouring a very small amount of water around the bottom of the A-frame spikes before each Fault-Find will generally ensure a good ground connection.

**NOTE:** If the cable runs under a paved surface, the fault can often be pinpointed by fault finding in the grass/soil adjacent to the paving. Reduce the distance between placing the A-frame spikes in the ground to allow for the increased distance to the actual fault position.

# Section 12. – Current direction (CD)

## 12.1 Understanding CD

Current direction recognition is a feature that helps to positively identify a line at points distant from the application of the signal. It is highly desirable, if not essential, for positive identification of long distance lines. These lines can be traced and positively identified through congested areas or when running parallel to other lines.

The CD feature on the RD8000PDL and PDLB receivers indicates the direction of the current flow on a line. Identity of the target line is established if the receiver display indicates that the current is flowing forward and away from the point of application of the transmitter signal.

**NOTE: CD mode is not supported on the RD8000 PXL and PXLB.**

A signal that has coupled onto adjacent lines finds a return path to the point of the original signal application. This is indicated by the receiver arrow pointing back towards the transmitter.

This is in contrast to the forward pointing arrow indicating the target line.

The CD transmitter signal must be directly coupled to the target line and with a remote ground connection. It cannot be applied by normal clamp or induction but can be applied with a transmitter CD clamp.

### 12.1.1 Using Current Direction (CD) to aid identification

The RD8000 PDL and PDLB receiver and Tx10 and Tx10B transmitters feature several CD frequencies to help you determine the direction of current through a target line.

**Note: The transmitter and receiver must both have the same CD frequency or frequencies installed to enable the feature to be used. If you have more than one CD frequency installed ensure that the transmitter and receiver are both set to the same CD frequency.**

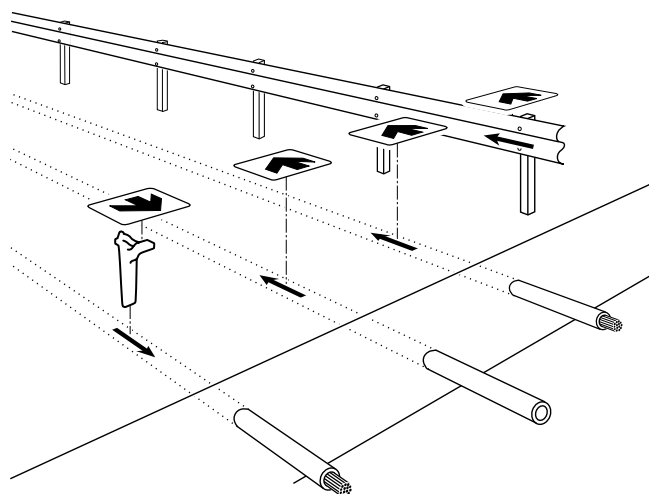

Figure 12.1: Current direction

To select the CD frequency, proceed as follows:

#### RD8000 transmitter

1. Connect the transmitter to target cable or pipe, either by direct connection or by using a CD clamp.
2. Switch the transmitter on.
3. Press the  $f$  key until the CD frequency is displayed.

CD is a combination of two frequencies, a CD frequency and a locate frequency.

#### RD8000PDL or PDLB receiver

1. Switch the receiver on.
2. Press the  $f$  key until the CD frequency is displayed, indicated by the two small arrows above the frequency value.
3. The receiver will switch back to locating mode.



## 12.2 CD reset

### 12.2.1 About CD reset

When you trace a signal on very long target lines, the transmitter signal gradually bleeds into the ground by capacitance. This means the phase angle of the remaining signal gradually changes.

This is referred to as phase-shift and can occur whenever an alternating current signal is flowing in a system of conductors that have a significant capacitance or inductance. The relative phase angle between the two frequencies will alter, but only over extended distances.

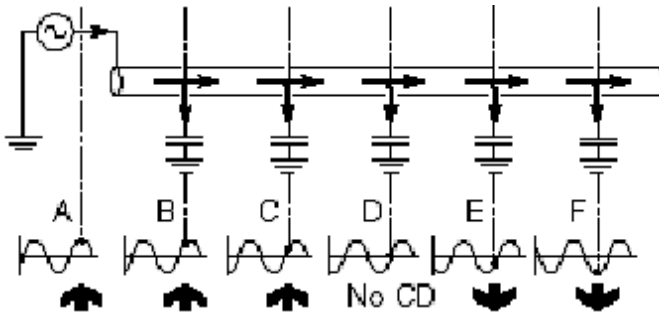

Figure 12.2: CD reset

Figure 12.2 illustrates a buried line with significant capacitance to ground. It illustrates the gradual phase-shift that occurs along the line. The diagram shows a reference point on each waveform. At first, the reference point occurs right on the peak of a positive half cycle (A). It gradually moves towards the zero crossing point (D) and ends up on the peak of a negative half cycle (F). The direction has shifted from forwards to backwards. At the intermediate point (D) the current flow cannot be determined. At this point the CD arrows on the RD8000 receiver will flash on and off. In the example shown in the illustration, by returning to (C) which is the last point at which a CD reading was achieved, and performing a CD reset, the response at (C) will be equivalent to that of (A).

In most cases the phase angle shift does not occur until many kilometers from the transmitter and in some cases a CD rest may only be required every 20 kilometers (14 miles).

### 12.2.2 Using a CD clamp or stethoscope

When using either of these accessories it is important to RESET the CD at a known point, near the transmitter, before making any identification measurements. On both the CD/CM clamp and the CD stethoscope there is an arrow that indicates which way the clamp or stethoscope is facing in relation to the transmitter. If the arrow is pointing away from the transmitter when the CD reset is performed the receiver display shows 000 and the bar graph reads 100%. If the arrow is pointing towards the transmitter, the receiver display shows 111 and there is no bar graph reading.

Refer to Section 10 for more information on clamps and stethoscopes.

### 12.2.3 Performing a CD reset

You must perform a CD every time you select a CD frequency. CD reset can only be performed when in CD mode.

#### To perform a CD reset:

1. Select any CD frequency using the  $f$  key.
2. Press the  $\text{⏻}$  key to enter the menu.
3. Scroll to the CDR menu using the  $\uparrow$  or  $\downarrow$  arrows.
4. Press the  $\text{⏻}$  key to enter the CDR menu.
5. Press the  $f$  key to reset CD and exit to the main menu.

7

# Section 13. – Appendices

## 13.1 Care and maintenance

The RD8000 receiver and transmitter is robust, durable and weatherproof. However you can extend your equipment's life by following these care and maintenance guidelines.

### 13.1.1 General

Store the equipment in a clean and dry environment.

Regularly validate your equipment using eCAL. Validation ensures the equipment is valid according to its original factory calibration. (See Appendix 13.3)

Ensure all terminals and connection sockets are clean, free of debris and corrosion and are undamaged.

Do not use this equipment when damaged or faulty.

### 13.1.2 Batteries and power supply

Use good quality Alkaline or NiMH batteries only.

When using an AC adapter, use only Radiodetection approved adapters.

### 13.1.3 Cleaning

**⚠ WARNING! Do not attempt to clean this equipment when it is powered or connected to any power source, including batteries, adapters and live cables.**

Ensure the equipment is clean and dry whenever possible.

Clean this equipment with soft, moistened cloth.

If using this equipment in foul water systems or other areas where biological hazards may be present, use an appropriate disinfectant.

Do not use abrasive materials or chemicals as they may damage the casing, including the reflective labels.

Do not use high pressure hoses.

### 13.1.4 Disassembly

Do not attempt to disassemble this equipment under any circumstances. The receiver and transmitter contain no user serviceable parts.

Disassembly may damage the equipment and or reduce its performance and may void the manufacturer's warranty.

### 13.1.5 Service and maintenance

Radiodetection recommends that you service your RD8000 receiver and transmitter regularly. Service your equipment at Radiodetection headquarters or Radiodetection authorized service centers.

**NOTE: Service by non-approved service centers or operators may void the manufacturer's warranty.**

## 13.2 Upgrading firmware

From time to time, Radiodetection will release firmware upgrades to enhance features and improve performance.

You can upgrade your RD8000's firmware by using Centros™ Manager and your desktop or notebook computer. Centros™ Manager is available from [www.radiodetection.com](http://www.radiodetection.com).

**NOTE: You must first register for an extended 3-year warranty before you can upgrade your RD8000 receiver. Registration is free.**

For more information please visit [www.radiodetection.com](http://www.radiodetection.com)

## 13.3 eCAL™

eCAL is part of the Centros™ Manager suite. With eCAL you can validate your RD8000 receiver against its original factory calibration.

eCAL can issue a pass or fail certificate, which you can print or save with your desktop or notebook computer.

**NOTE: You must first register for an extended 3-year warranty and purchase a Validation key before you can validate your RD8000 receiver.**

For more information please visit [www.radiodetection.com](http://www.radiodetection.com)



## 13.4 Specifications for the receiver and transmitter

Sensitivity	6E-15 Tesla, 5µA at 1 meter (33Hz)
Dynamic range	140dB rms/√Hz
Selectivity	120dB/Hz
Depth accuracy	Line: ± 2.5% tolerance 0.1m (4") to 3m (10ft) Sonde: ± 2.5% tolerance 0.1m (4") to 7m (23ft)
Maximum depth*	Line 6m (20ft), Sonde 18m (60ft)
Locate accuracy	± 2.5%
CD Fault-Finding (CDFF)	220Hz to 4kHz
Fault-Finding (FF)	Diagnose cable sheath faults from short circuit to 2MΩ using the A-frame
Batteries	Rx: 2 x D-cells (LR20) Tx: 8 x D-cells (LR20)
Battery life	Rx: 30 hours intermittent Tx: use dependent on signal conditions typically 15 hours Tx rechargeable battery pack: 8-hours on high power output
Warranty	36 Months upon registration
Dynamic overload protection	30dB (automatic)
Compliance	FCC, RSS 310 RoHS, Weee
Approvals	CE, <i>Bluetooth</i> ®
Weight	Tx: = 2.84kg (6lbs) (including batteries) 4.2kg (9lbs) (including accessories) Rx: =1.87kg (4lbs) (including batteries)
Environment	IP54

## 13.5 Supported frequencies

Model	PXL	PXLB	PDL	PDLB
Power	•	•	•	•
Radio	•	•	•	•
Passive Avoidance			•	•
CATV 50/60Hz			•	•
CPS 100/120Hz			•	•
Active ELF (98/128Hz)			•	•
Active 570Hz			•	•
Active 577Hz	•	•	•	•
Active LF (512/640Hz)	•	•	•	•
Active 760Hz			•	•
Active 870Hz	•	•	•	•
Active 920Hz	•	•	•	•
Active 8kHz	•	•	•	•
Active 9.8kHz			•	•
Active 33kHz	•	•	•	•
Active 65kHz	•	•	•	•
Active 83kHz	•	•	•	•
Active 131kHz	•	•	•	•

Active 200kHz	•	•	•	•
CD 256Hz			•	•
CD 285Hz			•	•
CD 320Hz			•	•
CD 380Hz			•	•
CD 460Hz			•	•
Sonde 512Hz/640Hz	•	•	•	•
Sonde 8kHz	•	•	•	•
Sonde 33kHz	•	•	•	•
FF 8kHz (8kFF)			•	•
FF CD			•	•

## 13.6 Supported accessories

Description	Part Number
<b>Transmitter Accessories</b>	
UK Plug Connector	10/AC1231-4KTX-LPC-UK
Euro Plug Connector	10/AC1231-4KTX-LPC-EUR
Live Cable Connector	10/AC1231-4KTX-LCC
2" (50mm) Transmitter Clamp	10/TC2136-4KTX
4" (100mm) Transmitter Clamp	10/TC1769-4KTX
CD Transmitter Clamp	10/TC2651-4KTX
Earth Reel	09/310-4KTX
Mains power AC transformer to 12V DC New	10/RD7K8KUMPSU
Tx Direct Connection Lead	17/TX2609E1
Earth Stake	04/PT1505N27
New Short Earth Stake	04/ET2980P8
8.5" (215mm) Transmitter Clamp	10/RD4GT0235
Signal Clamp Extension Rod	10/EXT
121 Transformer	10/RD2717-4KTX-ENG
12V Car Power Lead (with Isolation Transformer) New	10/RD7K8KDCI
<b>Receiver Accessories</b>	
High Gain Stethoscope	10/AC2645-4KRX
Small Stethoscope	10/AC2643-4KRX
Large Stethoscope	10/AC2644-4KRX
640/512Hz Submersible DD Antenna (10m Cable)	10/SM1099-640-4KRX
8kHz Submersible DD Antenna (10m Cable)	10/SM1099-8-4KRX
Additional Submersible Cable Length (Per Meter)	10/RD0246SUBCABL
Headphones	04/LP01
A Frame	10/AFRAME
A Frame Bag	10/RD4FFRXBAG
50mm (2") Receiver Clamp	10/TC2136-4KRX

100mm (4") Receiver Clamp	10/TC1769-4KRX
CD Receiver Clamp	10/CM2054-4KRX
CD Stethoscope	10/AC2666-4KRX
Soft Carry Bag	10/RD7K8KBAG
Soft Carry Bag with Wheels New	10/RD7K8KRBAG
Hard Case	10/RD7K8KCASE
<b>Sondes and Accessories</b>	
Standard Sonde 33kHz Depth 5m	10/SC0412-33R
Sewer Sonde 33kHz Depth 8m	10/SA0337-33R
Super Sonde 33kHz Depth 15m	10/SB0338-33R
Slim Sonde 33kHz Depth 3.5m	10/SD0322-33R
Slim Sonde Plain End Cap	10/SD0223
Slim Sonde Blank End Cap	10/SD0268
S18A Sonde 33kHz	10/S18/82-33-000
S18B Sonde 33kHz	10/S18/173-33-000
8kHz Sonde	10/SCO412-8
512Hz Sonde	10/SCO412-512
Spring Coupling M10 Male	10/SU0335
Flexrod Coupler (Joins two Flexrods together)	02/FR0818N1
Flexrod Blank for Machinery	02/FR0336
115mm (4.5") Diameter Floats/Pair	10/SU0344
M10 Thread Protecting Nipple	02/P1050
External Shell for heavy-duty applications (Diameter as Sewer Sonde)	10/SC0963
Plastic or Cane Rod Connector, Male	02/SU0339
GD Rod Connector. 3/4" (19mm) x 12 BSF, Female	02/SU0340
Wards Rod Connector, 3/4" (19mm) x 10 BSW, Female	02/SU0341
Wards Rod Connector, 1/2" (13mm) x 12 BSW, Female	02/SU0342
Lockfast Connector, 3/4" (19mm) x 10 BSW	02/SU0676
Spring Coupling M10 Male	10/SU0335
FlexiTrace 50m	10/TRACE50
9mm 120m Flexrod	10/FLEXRODF120
9mm 60m Flexrod	10/FLEXRODF60
<b>Batteries and Rechargeables</b>	
Alkaline Battery for RD7000, RD8000, Tx-1, Tx-3, Tx-10 (LR20, MN1300)	04/MN1300
Transmitter Li-Ion rechargeable battery pack (Incl mains and 12V chargers and leads)	10/TXRBATPACKKIT
Transmitter Li-Ion rechargeable battery pack	10/TXRBATPACK

## World leaders



Radiodetection is a proud member of the SPX group of companies, which provide technical products and service solutions worldwide.

Radiodetection and its associated companies specialize in the design and manufacture of products for the location and maintenance of underground pipes and cables. Our aim is to be viewed as the supplier of choice of 'high performance' quality equipment using advanced product technologies. We are also committed to both design innovation and customer support.

## Technical support



Radiodetection equipment users have easy access to technical support. A call to your regional representative, or the Radiodetection head office, will put you in contact with our team of field-experienced technical experts.

## Servicing and repair



Radiodetection has a team of factory-trained service technicians and dedicated service facilities. Turnaround is fast, and costs are very competitive.

## Training



Product training for your operators and training personnel is available on your site, or at Radiodetection's headquarters. Training is with qualified instructors and each trainee receives a certificate to confirm they have received the training.

### America

#### Radiodetection

154 Portland Road  
Bridgton, ME 04009, USA  
Tel: +1 (207) 647 9495  
Toll Free: +1 (877) 247 3797  
Fax: +1 (207) 647 9496  
Email: [rd.sales.us@spx.com](mailto:rd.sales.us@spx.com)  
Web: [www.radiodetection.com](http://www.radiodetection.com)

#### Pearpoint

72055 Corporate Way  
Thousand Palms CA 92276, USA  
Tel: +1 800 688 8094  
Tel: +1 760 343 7350  
Fax: +1 760 343 7351  
Email: [pearpoint.sales.us@spx.com](mailto:pearpoint.sales.us@spx.com)  
Web: [www.radiodetection.com](http://www.radiodetection.com)

#### Radiodetection (Canada)

Unit 34, 344 Edgeley Blvd.  
Concord, Ontario, Canada L4K 4B7  
Tel: +1 (905) 660 9995  
Toll Free: +1 (800) 665 7953  
Fax: +1 (905) 660 9579  
Email: [rd.sales.ca@spx.com](mailto:rd.sales.ca@spx.com)  
Web: [www.radiodetection.com](http://www.radiodetection.com)

### Europe

#### Radiodetection Ltd (UK)

Western Drive  
Bristol BS14 0AF, UK  
Tel: +44 (0) 117 976 7776  
Fax: +44 (0) 117 976 7775  
Email: [rd.sales.uk@spx.com](mailto:rd.sales.uk@spx.com)  
Web: [www.radiodetection.com](http://www.radiodetection.com)

#### Radiodetection (France)

13 Grande Rue, 76220  
Neuf Marché, France  
Tel: +33 (0) 232 8993 60  
Fax: +33 (0) 235 9095 58  
Email: [rd.sales.fr@spx.com](mailto:rd.sales.fr@spx.com)  
Web: <http://fr.radiodetection.com>

#### Radiodetection (Benelux)

Industriestraat 11  
7041 GD 's-Heerenberg, Netherlands  
Tel: +31 (0) 314 66 47 00  
Fax: +31 (0) 314 66 41 30  
Email: [rd.sales.nl@spx.com](mailto:rd.sales.nl@spx.com)  
Web: <http://nl.radiodetection.com>

#### Radiodetection (Germany)

Groendahlscher Weg 118  
46446 Emmerich am Rhein, Germany  
Tel: +49 (0) 28 51 92 37 20  
Fax: +49 (0) 28 51 92 37 520  
Email: [rd.sales.de@spx.com](mailto:rd.sales.de@spx.com)  
Web: <http://de.radiodetection.com>

### Asia-Pacific

#### Radiodetection (Asia-Pacific)

Room 708, CC Wu Building  
302-308 Hennessy Road, Wan Chai  
Hong Kong SAR, China  
Tel: +852 2110 8160  
Fax: +852 2110 9681  
Email: [rd.sales.cn@spx.com](mailto:rd.sales.cn@spx.com)  
Web: [www.radiodetection.com](http://www.radiodetection.com)

#### Radiodetection (China)

Hongfu Mansion, Room 61622  
Zheng Ge Zhuang, Bei Qi Jia Town,  
Chang Ping District  
Beijing 102209, China  
Tel: +86 (0) 10 8975 5540  
Fax: +86 (0) 10 8975 5640  
Email: [rd.service.cn@spx.com](mailto:rd.service.cn@spx.com)  
Web: <http://cn.radiodetection.com>

#### Radiodetection (Australia)

Unit 14, 5-7 Prosperity Parade  
Warriewood NSW 2102, Australia  
Tel: +61 (0) 2 9979 8555  
Fax: +61 (0) 2 9979 7733  
Email: [rd.sales.au@spx.com](mailto:rd.sales.au@spx.com)  
Web: [www.radiodetection.com](http://www.radiodetection.com)

To see the full range of products and services provided by Radiodetection visit:

[www.radiodetection.com](http://www.radiodetection.com)

Radiodetection products are under continuous development and are subject to change, we reserve the right to alter or amend any published specification without notice.  
Copyright 2008 Radiodetection Ltd. - SPX Corporation. All rights reserved. Radiodetection Ltd. is a subsidiary of SPX Corporation.



**Radiodetection**  
AN SPX COMPANY